



Industrial Rubber Products

Astro-Tex Company Profile

Astro-Tex was founded in 1974 in Plano, Texas. It was our goal to supply the OEM Market with high quality rubber products. It was also our intention to create a full line of industry-standard rubber products that the OEM's could use and engineer into their existing and new product developments. These products would be available to them for same-day shipping. As programs such as JIT evolved, so did Astro-Tex...investing in new tooling and increased inventory levels to keep up with increasing customer requirements. Today our inventory includes hundreds of stock and custom parts.

Astro-Tex is known for custom part capabilities, whether it's a single cavity prototype tool or a large production run tool. Astro-Tex can be your supplier for custom parts; send us a print, sketch or existing part and let us quote to your specification.

Our extrude program is one of the best in the industry. Small run extrusion jobs are not a problem at Astro-Tex, where we've learned that not every customer needs thousands of feet of extrusion. Astro-Tex offers 100-foot minimum runs, even with custom profiles.

Astro-Tex is also an authorized distributor for Lord Corporation, an industry leader in the manufacturing of rubber to metal vibration isolation products. In order for machinery to work at its full potential, Lord Vibration mounts can isolate equipment from other sources of vibration, relieving equipment from undue vibration, noise and stress. These products have also been incorporated into our standard product line, facilitating immediate delivery for our customers.

Our experienced staff will help answer technical questions and help you select the correct parts along with the proper material for your application. Astro-Tex Shipping Department hours are the same as the sales department. That means we ship orders right up to 4:00PM.

Remember, at Astro-Tex we pride ourselves on fast, friendly and reliable service. We won't "rub"ber you the wrong way.

Table of Contents

| | |
|---|--------------------|
| Grommets | |
| Stock | 2-4 |
| Manufactured | 5-7 |
| Military | 8 |
| Recessed Bumpers | |
| Stock | 9 |
| Manufactured | 10 |
| Stem Bumpers | |
| Stock | 11 |
| Manufactured | 12-13 |
| Catch Bumpers | |
| Stock | 14 |
| Manufactured | 15-17 |
| Bumper Pads | 18 |
| Screw Bumpers | 19 |
| Truck Bumpers | 20 |
| Molded Parts | 21 |
| 3M Bumpers | 22 |
| Laboratory Stoppers | 23 |
| Crutch Tips | 24 |
| End Tips | |
| Stock | 25 |
| Manufactured | 26-27 |
| Step Bushings | |
| Stock | 28 |
| Manufactured | 29 |
| Extrusions | |
| U Channels | 30 |
| Custom Short Run | 31 |
| Custom Extrusions | 32 |
| Lifter Tools | 33-34 |
| Suction Cups | |
| Stock | 35-36 |
| Manufactured | 37 |
| Lord Vibration Mounts | 38 |
| Lathe Cut Parts & Sheet Rubber | 39 |
| General Information | 40 |
| Company Information | Inside Front Cover |
| How To Purchase/Conditions of Sale | Inside Back Cover |

GROMMETS

Stock grommets are available in 60 durometer black SBR. Listed below by increasing **Inside Diameter (A)** are the grommets that are considered stock items. Check our manufactured grommet section if you cannot find a particular item in this section. **Low minimum orders for stocked parts.**



| A INSIDE DIAMETER | B GROOVE WIDTH | C GROOVE DIAMETER | D OUTSIDE DIAMETER | E OVERALL THICKNESS | PART # |
|-------------------------|----------------------|-------------------------|--------------------------|---------------------------|----------|
| 7/64" | 3/64" | 1/2" | 11/16" | 9/32" | M-1272 |
| 1/8" | 1/32" | 3/16" | 1/4" | 3/32" | M-1070 |
| 1/8" | 1/16" | 1/4" | 11/32" | 3/16" | M-0054-G |
| 1/8" | 3/32" | 3/8" | 1/2" | 5/16" | M-2425 |
| 1/8" | 9/32" | 3/8" | 1/2" | 1/2" | M-2424 |
| 5/32" | 1/16" | 1/4" | 3/8" | 3/16" | M-1259 |
| 5/32" | 1/16" | 9/32" | 15/32" | 19/64" | M-1783 |
| 5/32" | 3/32" | 1/4" | 7/16" | 3/8" | M-0374 |
| 3/16" | 1/16" | 5/16" | 7/16" | 3/16" | M-2286 |
| 3/16" | 1/16" | 5/16" | 1/2" | 1/4" | M-1453 |
| 3/16" | 3/16" | 3/8" | 5/8" | 3/8" | M-0704 |
| 3/16" | 1/16" | 9/16" | 3/4" | 3/16" | M-2279 |
| 3/16" | 3/32" | 9/32" | 7/16" | 7/32" | M-1734 |
| 3/16" | 1/8" | 5/16" | 7/16" | 1/4" | M-2852 |
| 3/16" | 1/8" | 5/8" | 7/8" | 1/4" | M-3760 |
| 3/16" | 3/16" | 5/16" | 7/16" | 5/16" | M-2752 |
| 3/16" | 1/4" | 5/16" | 7/16" | 3/8" | M-2552 |
| 7/32" | 1/16" | 5/16" | 7/16" | 3/16" | M-1411 |
| 1/4" | 1/16" | 3/8" | 1/2" | 7/32" | M-2902 |
| 1/4" | 1/16" | 7/16" | 5/8" | 3/16" | M-0097 |
| 1/4" | 1/16" | 1" | 1-1/4" | 1/4" | M-2298 |
| 1/4" | 3/32" | 3/8" | 1/2" | 1/4" | M-2901 |
| 1/4" | 3/32" | 7/16" | 5/8" | 3/8" | M-0680 |
| 1/4" | 1/8" | 3/8" | 1/2" | 9/32" | M-2903 |
| 1/4" | 1/8" | 7/16" | 5/8" | 1/4" | M-2854 |
| 1/4" | 3/16" | 7/16" | 5/8" | 5/16" | M-2754 |
| 1/4" | 1/4" | 7/16" | 5/8" | 3/8" | M-2554 |
| 1/4" | 1/4" | 15/32" | 5/8" | 1/2" | M-0696 |
| 9/32" | 1/16" | 3/8" | 9/16" | 1/4" | M-0763 |
| 9/32" | 1/4" | 15/32" | 11/16" | 7/16" | M-0190 |
| 5/16" | 1/16" | 7/16" | 9/16" | 3/16" | M-0263 |
| 5/16" | 1/16" | 7/16" | 5/8" | 9/32" | M-0505 |

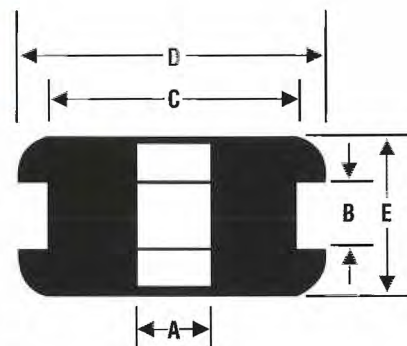

Use Our Stock Grommets
In Your Application To
Save Time & Money

SBR

(Styrene-Butadiene)

SBR offers **excellent tear strength, high resilience & tensile strength, good abrasion resistance and a temperature range of -60°F through 180°F.**

Note: SBR should not be used in a chemical or fuel environment.

Stock Grommets

▼ If you can't find the part you are looking for in this catalog, please call. We have the capability to make any part you need.

▼ Our goal is to have your grommet in stock when you need it, whether it's a standard stock part or one of your custom part requirements.

▼ When you need help in determining the type of rubber to use, call us and we'll gladly help you find the optimal material for your application.

▼ When you need to see and fit the grommet into your application, we'll sample parts for your evaluation.

Grommet Benefits

▼ Use grommets to eliminate wear on electrical wiring running through sharp holes.

▼ Grommets can be used to make a seal around pipes or wiring.

▼ Grommets can be used cosmetically, making drilled or punched holes look better.

▼ Grommets can be used under light equipment to reduce noise and vibration.

| A INSIDE DIAMETER | B GROOVE WIDTH | C GROOVE DIAMETER | D OUTSIDE DIAMETER | E OVERALL THICKNESS | PART # |
|-------------------------|----------------------|-------------------------|--------------------------|---------------------------|--------|
| 5/16" | 1/16" | 9/16" | 13/16" | 5/16" | M-2113 |
| 5/16" | 1/16" | 3/4" | 1" | 5/16" | M-2280 |
| 5/16" | 3/32" | 7/16" | 5/8" | 5/16" | M-2538 |
| 5/16" | 3/32" | 15/32" | 3/4" | 11/32" | M-2214 |
| 5/16" | 1/8" | 9/16" | 13/16" | 3/8" | M-2856 |
| 5/16" | 1/8" | 3/4" | 1" | 3/8" | M-2857 |
| 5/16" | 3/16" | 9/16" | 13/16" | 7/16" | M-2756 |
| 5/16" | 3/16" | 3/4" | 1" | 7/16" | M-2757 |
| 5/16" | 3/8" | 3/8" | 9/16" | 1/2" | M-0316 |
| 5/16" | 1/4" | 9/16" | 13/16" | 1/2" | M-2556 |
| 5/16" | 1/4" | 3/4" | 1" | 1/2" | M-2557 |
| 3/8" | 1/16" | 1/2" | 5/8" | 1/4" | M-0230 |
| 3/8" | 1/16" | 1/2" | 11/16" | 9/32" | M-1724 |
| 3/8" | 1/16" | 5/8" | 7/8" | 5/16" | M-2281 |
| 3/8" | 1/16" | 1" | 1 1/4" | 1/4" | M-2299 |
| 3/8" | 1/8" | 1/2" | 5/8" | 13/32" | M-0545 |
| 3/8" | 1/8" | 17/32" | 3/4" | 3/8" | M-0546 |
| 3/8" | 1/8" | 5/8" | 7/8" | 3/8" | M-2858 |
| 3/8" | 3/16" | 9/16" | 13/16" | 3/8" | M-0896 |
| 3/8" | 3/16" | 5/8" | 7/8" | 7/16" | M-2758 |
| 3/8" | 1/4" | 1/2" | 3/4" | 1/2" | M-0828 |
| 3/8" | 1/4" | 5/8" | 7/8" | 1/2" | M-2558 |
| 3/8" | 3/8" | 9/16" | 3/4" | 3/4" | M-2596 |
| 7/16" | 1/16" | 9/16" | 3/4" | 1/4" | M-1787 |
| 7/16" | 1/16" | 11/16" | 15/16" | 5/16" | M-2282 |
| 7/16" | 1/8" | 11/16" | 15/16" | 3/8" | M-2860 |
| 7/16" | 3/16" | 9/16" | 11/16" | 3/8" | M-0560 |
| 7/16" | 3/16" | 11/16" | 15/16" | 7/16" | M-2760 |
| 7/16" | 1/4" | 11/16" | 15/16" | 1/2" | M-2560 |
| 1/2" | 1/16" | 13/16" | 1-1/16" | 5/16" | M-2283 |
| 1/2" | 1/16" | 1" | 1-1/4" | 1/4" | M-2426 |
| 1/2" | 1/16" | 1-1/4" | 1-1/2" | 1/4" | M-2284 |
| 1/2" | 3/32" | 3/4" | 7/8" | 11/32" | M-0452 |
| 1/2" | 3/32" | 3/4" | 31/32" | 9/32" | M-1862 |
| 1/2" | 1/8" | 3/4" | 1" | 1/2" | M-0653 |
| 1/2" | 1/8" | 13/16" | 1-1/16" | 3/8" | M-2861 |
| 1/2" | 3/16" | 13/16" | 1-1/16" | 7/16" | M-2761 |
| 1/2" | 1/4" | 13/16" | 1-1/16" | 1/2" | M-2561 |
| 1/2" | 3/8" | 3/4" | 1" | 5/8" | M-0807 |
| 1/2" | 1/16" | 1-7/16" | 1-3/4" | 3/8" | M-2339 |
| 9/16" | 1/16" | 3/4" | 7/8" | 15/64" | M-1720 |
| 9/16" | 1/16" | 13/16" | 1-1/16" | 5/16" | M-2295 |
| 9/16" | 3/16" | 7/8" | 1-1/16" | 7/16" | M-2512 |
| 9/16" | 3/8" | 7/8" | 1-1/16" | 5/8" | M-2513 |
| 9/16" | 1" | 13/16" | 1-1/8" | 1-1/4" | M-2406 |
| 9/16" | 3/16" | 13/16" | 1-1/16" | 7/16" | M-2763 |
| 9/16" | 1/4" | 13/16" | 1-1/16" | 1/2" | M-2563 |
| 5/8" | 1/16" | 7/8" | 1-1/8" | 5/16" | M-2285 |

STOCK GROMMETS, CONTINUED

| A INSIDE DIAMETER | B GROOVE WIDTH | C GROOVE DIAMETER | D OUTSIDE DIAMETER | E OVERALL THICKNESS | PART # |
|-------------------------|----------------------|-------------------------|--------------------------|---------------------------|---------|
| 5/8" | 1/16" | 1-1/4" | 1-1/2" | 1/4" | M-2296 |
| 5/8" | 1/8" | 7/8" | 1-1/8" | 3/8" | M-2864 |
| 5/8" | 3/16" | 7/8" | 1-1/8" | 7/16" | M-2764 |
| 5/8" | 1/4" | 7/8" | 1-1/8" | 1/2" | M-2564 |
| 5/8" | 5/16" | 29/32" | 1-1/8" | 5/8" | M-0494 |
| 11/16" | 1/16" | 1" | 1-5/16" | 3/8" | M-2273 |
| 11/16" | 1/8" | 1" | 1-5/16" | 7/16" | M-2866 |
| 11/16" | 3/16" | 1" | 1-5/16" | 1/2" | M-2766 |
| 11/16" | 1/4" | 1" | 1-5/16" | 9/16" | M-2566 |
| 3/4" | 1/16" | 15/16" | 1-1/8" | 1/4" | M-2196 |
| 3/4" | 1/16" | 1-1/16" | 1-3/8" | 3/8" | M-0804 |
| 3/4" | 1/16" | 1-1/4" | 1-5/8" | 1/4" | M-2274 |
| 3/4" | 1/16" | 1-7/16" | 1-13/16" | 3/8" | M-2275 |
| 3/4" | 1/8" | 1-1/16" | 1-3/8" | 7/16" | M-2867 |
| 3/4" | 1/8" | 1-1/16" | 1-3/8" | 7/16" | M-2867 |
| 3/4" | 1/4" | 1-1/16" | 1-3/8" | 9/16" | M-2567 |
| 3/4" | 1/4" | 1-7/16" | 1-13/16" | 9/16" | M-0108 |
| 3/4" | 3/16" | 1-1/16" | 1-3/8" | 1/2" | M-2767 |
| 3/4" | 1/4" | 1-1/4" | 1-5/8" | 7/16" | M-2568 |
| 13/16" | 9/16" | 15/16" | 1-1/4" | 7/8" | M-5632 |
| 7/8" | 1/16" | 1-1/4" | 1-5/8" | 7/16" | M-2276 |
| 7/8" | 1/16" | 1-5/8" | 2" | 7/16" | M-2300 |
| 7/8" | 5/64" | 1-3/16" | 1-3/8" | 15/32" | M-1626 |
| 7/8" | 1/8" | 1-1/4" | 1-5/8" | 1/2" | M-2870 |
| 7/8" | 9/64" | 1-3/16" | 1-3/8" | 15/32" | M-1626A |
| 7/8" | 3/16" | 1-1/4" | 1-5/8" | 9/16" | M-2770 |
| 7/8" | 3/16" | 1-15/64" | 1-9/16" | 3/4" | M-2595 |
| 7/8" | 1/4" | 1-1/4" | 1-5/8" | 5/8" | M-2570 |
| 1" | 1/16" | 1-3/8" | 1-3/4" | 7/16" | M-2277 |
| 1" | 1/16" | 1-7/8" | 2-1/4" | 7/16" | M-2301 |
| 1" | 1/8" | 1-3/8" | 1-3/4" | 1/2" | M-2872 |
| 1" | 3/16" | 1-3/8" | 1-3/4" | 9/16" | M-2772 |
| 1" | 1/4" | 1-1/4" | 1-1/2" | 1/2" | M-2035 |
| 1" | 1/4" | 1-3/8" | 1-3/4" | 5/8" | M-2572 |
| 1-1/8" | 1/16" | 1-1/2" | 1-7/8" | 3/8" | M-2092 |
| 1-1/4" | 1/4" | 1-5/8" | 1-7/8" | 9/16" | M-6313 |
| 1-5/16" | 1/16" | 1-5/8" | 2" | 3/8" | M-2803 |
| 1-5/16" | 1/8" | 1-5/8" | 2" | 7/16" | M-2802 |
| 1-1/2" | 1/16" | 1-3/4" | 2-1/8" | 7/16" | M-2278 |
| 1-1/2" | 1/8" | 1-3/4" | 2-1/8" | 1/2" | M-2875 |
| 1-1/2" | 3/16" | 1-3/4" | 2-1/8" | 9/16" | M-2775 |
| 1-1/2" | 1/4" | 1-3/4" | 2" | 1/2" | M-2034 |
| 1-1/2" | 1/4" | 1-3/4" | 2-1/8" | 5/8" | M-2575 |
| 1-1/2" | 3/8" | 1-3/4" | 2-3/32" | 3/4" | M-2576 |
| 1-3/4" | 1/16" | 2" | 2-5/16" | 7/16" | M-3357 |
| 2" | 1/32" | 2-1/2" | 3" | 9/32" | M-0561 |
| 2-1/8" | 1/16" | 2-1/2" | 2-7/8" | 7/16" | M-2805 |
| 2-1/8" | 1/8" | 2-1/2" | 2-7/8" | 7/16" | M-2804 |

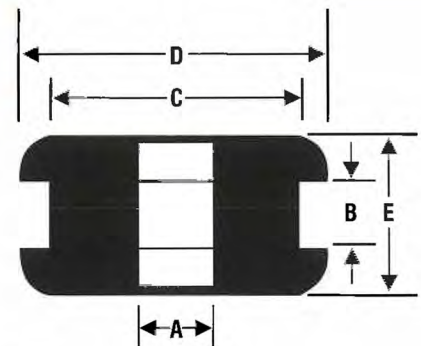

We Offer One Of The
Largest Inventories
Of Stock Grommets

If You Have Questions
About Rubber,
We're Here To Help

DUROMETER

? The hardness of the rubber.
Durometer is measured by the
resistance of the stock to indentation
by the blunt point of a metal rod or
needle. Readings are from 0-100.
Shore (A) scale ASTM D 2240 is used
for most compounds. Lower numbers
indicate soft material.

MANUFACTURED GROMMETS

Listed below by increasing **Inside Diameter (A)** are manufactured grommets available in a variety of materials. Minimums for production runs apply; please call for specific information. Normal delivery is 4-6 weeks with a minimum order of \$200.00, but a special 10-working-day expedite is offered on most manufactured parts.

| SEE DRAWING | A INSIDE DIAMETER | B GROOVE WIDTH | C GROOVE DIAMETER | D OUTSIDE DIAMETER | E OVERALL THICKNESS | PART # |
|-------------|-------------------------|----------------------|-------------------------|--------------------------|---------------------------|---------|
| 1 | 1/16" | 1/16" | 3/16" | 9/32" | 3/16" | M-52127 |
| 1 | 3/32" | 1/16" | 3/8" | 1/2" | 3/16" | M-52174 |
| 1 | 3/32" | 3/64" | 7/16" | 5/8" | 1/4" | M-52253 |
| 1 | 7/64" | 1/16" | 13/64" | 11/32" | 3/16" | M-52104 |
| 1 | 7/64" | 3/64" | 1/2" | 11/16" | 9/32" | M-52937 |
| 1 | 1/8" | 1/32" | 3/16" | 1/4" | 1/8" | M-52101 |
| 1 | 1/8" | 1/16" | 3/16" | 11/32" | 3/16" | M-52102 |
| 1 | 1/8" | 1/16" | 3/16" | 11/32" | 3/16" | M-52105 |
| 1 | 1/8" | 1/16" | 3/16" | 5/16" | 3/16" | M-52113 |
| 2 | 1/8" | 1/16" | 1/4" | 11/32" | 3/16" | M-50210 |
| 1 | 1/8" | 1/16" | 5/16" | 7/16" | 7/32" | M-52157 |
| 1 | 1/8" | 1/16" | 3/8" | 17/32" | 1/4" | M-52116 |
| 1 | 9/64" | 3/32" | 5/16" | 15/32" | 9/32" | M-52151 |
| 1 | 9/64" | 1/16" | 5/16" | 15/32" | 1/4" | M-52153 |
| 1 | 9/64" | 3/64" | 7/16" | 5/8" | 1/4" | M-52262 |
| 1 | 5/32" | 3/32" | 17/64" | 13/32" | 3/8" | M-50414 |
| 3 | 5/32" | 3/32" | 1/4" | 5/16" | 3/16" | M-52103 |
| 2 | 5/32" | 1/32" | 9/32" | 1/2" | 1/4" | M-52182 |
| 1 | 5/32" | 3/64" | 7/16" | 5/8" | 13/64" | M-52642 |
| 3 | 11/64" | 1/16" | 15/32" | 5/8" | 5/16" | M-52256 |
| 3 | 11/64" | 1/32" | 15/32" | 5/8" | 9/32" | M-52356 |
| 3 | 3/16" | 3/64" | 1/4" | 3/8" | 11/64" | M-52175 |
| 1 | 3/16" | 1/32" | 1/4" | 3/8" | 3/16" | M-52178 |
| 3 | 3/16" | 1/16" | 1/4" | 3/8" | 3/16" | M-52179 |
| 3 | 3/16" | 3/32" | 19/64" | 7/16" | 9/32" | M-52162 |
| 1 | 3/16" | 1/16" | 9/32" | 7/16" | 7/32" | M-52669 |
| 1 | 3/16" | 1/16" | 5/16" | 7/16" | 7/32" | M-50215 |
| 2 | 3/16" | 1/16" | 5/16" | 7/16" | 7/32" | M-50216 |
| 1 | 3/16" | 3/32" | 5/16" | 7/16" | 1/4" | M-50415 |
| 2 | 3/16" | 3/32" | 5/16" | 7/16" | 1/4" | M-50416 |
| 1 | 3/16" | 1/32" | 5/16" | 7/16" | 3/16" | M-52156 |
| 1 | 3/16" | 1/16" | 5/16" | 13/32" | 13/64" | M-52158 |
| 3 | 3/16" | 3/32" | 5/16" | 7/16" | 9/32" | M-52159 |
| 1 | 3/16" | 1/16" | 5/16" | 1/2" | 7/32" | M-52173 |
| 3 | 3/16" | 7/64" | 5/16" | 1/2" | 15/64" | M-52180 |
| 3 | 3/16" | 1/8" | 5/16" | 1/2" | 7/32" | M-52181 |
| 1 | 3/16" | 1/16" | 3/8" | 1/2" | 7/32" | M-50217 |
| 1 | 3/16" | 1/32" | 3/8" | 1/2" | 3/16" | M-52171 |
| 1 | 3/16" | 1/16" | 3/8" | 5/8" | 11/32" | M-52351 |
| 1 | 3/16" | 1/8" | 7/16" | 9/16" | 3/8" | M-52201 |
| 3 | 3/16" | 1/8" | 1/2" | 11/16" | 3/8" | M-52038 |
| 1 | 3/16" | 1/16" | 21/32" | 27/32" | 5/16" | M-52119 |

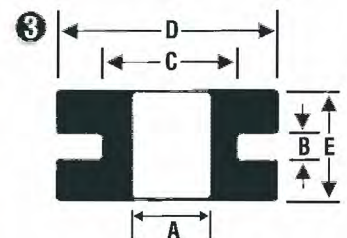
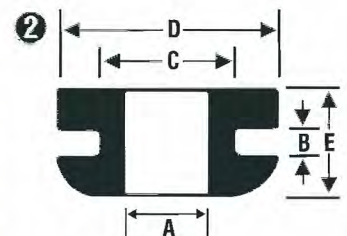
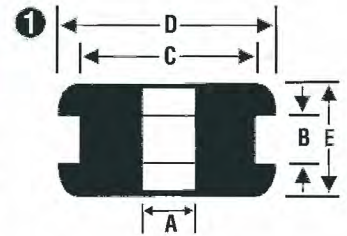

Manufactured Grommets

Manufactured grommets save time and money by eliminating the need for new mold and tooling costs.

If you can't find the part you are looking for in this catalog, please call. We have the capability to make any part you need.

When you need help in determining the type of rubber to use, call us and we'll gladly help you find the optimal material for your application.

MANUFACTURED GROMMETS, CONTINUED

| SEE DRAWING | A INSIDE DIAMETER | B GROOVE WIDTH | C GROOVE DIAMETER | D OUTSIDE DIAMETER | E OVERALL THICKNESS | PART # |
|-------------|-------------------------|----------------------|-------------------------|--------------------------|---------------------------|---------|
| 3 | 13/64" | 3/64" | 5/16" | 1/2" | 21/64" | M-52185 |
| 1 | 13/64" | 1/32" | 21/64" | 7/16" | 5/32" | M-52161 |
| 1 | 7/32" | 1/8" | 5/16" | 7/16" | 9/32" | M-52118 |
| 1 | 7/32" | 1/32" | 5/16" | 15/32" | 1/8" | M-52154 |
| 1 | 7/32" | 1/16" | 5/16" | 7/16" | 3/16" | M-52160 |
| 1 | 7/32" | 3/32" | 11/32" | 17/32" | 13/32" | M-50219 |
| 3 | 7/32" | 1/8" | 11/32" | 17/32" | 3/8" | M-52177 |
| 1 | 7/32" | 5/64" | 11/32" | 17/32" | 25/64" | M-52191 |
| 3 | 7/32" | 1/16" | 11/32" | 17/32" | 3/8" | M-52192 |
| 1 | 7/32" | 3/64" | 7/16" | 5/8" | 11/64" | M-52254 |
| 1 | 1/4" | 1/32" | 5/16" | 1/2" | 5/32" | M-52172 |
| 3 | 1/4" | 1/16" | 5/16" | 1/2" | 1/4" | M-52183 |
| 1 | 1/4" | 1/16" | 11/32" | 1/2" | 3/16" | M-52176 |
| 1 | 1/4" | 1/16" | 3/8" | 9/16" | 1/4" | M-50220 |
| 2 | 1/4" | 1/16" | 3/8" | 9/16" | 1/4" | M-50222 |
| 2 | 1/4" | 1/8" | 3/8" | 9/16" | 5/16" | M-50320 |
| 2 | 1/4" | 5/32" | 3/8" | 9/16" | 3/8" | M-52202 |
| 1 | 1/4" | 1/16" | 3/8" | 5/8" | 11/32" | M-52251 |
| 1 | 1/4" | 1/16" | 3/8" | 5/8" | 9/32" | M-52260 |
| 3 | 1/4" | 1/8" | 7/16" | 5/8" | 3/8" | M-52664 |
| 1 | 1/4" | 1/8" | 3/8" | 5/8" | 3/8" | M-53251 |
| 1 | 1/4" | 9/32" | 1/2" | 5/8" | 17/32" | M-52257 |
| 3 | 1/4" | 1/16" | 1-3/16" | 1-1/2" | 7/16" | M-51116 |
| 3 | 1/4" | 1/16" | 1-1/4" | 1-1/2" | 7/16" | M-51106 |
| 3 | 17/64" | 1/8" | 15/32" | 5/8" | 3/8" | M-50233 |
| 3 | 17/64" | 1/16" | 15/32" | 5/8" | 5/16" | M-52259 |
| 1 | 17/64" | 1/16" | 7/16" | 5/8" | 5/16" | M-52255 |
| 1 | 9/32" | 1/16" | 3/8" | 9/16" | 1/4" | M-50221 |
| 1 | 9/32" | 1/32" | 3/8" | 9/16" | 1/4" | M-52212 |
| 1 | 9/32" | 1/16" | 13/32" | 9/16" | 1/4" | M-52211 |
| 1 | 5/16" | 1/8" | 7/16" | 19/32" | 3/8" | M-50324 |
| 3 | 5/16" | 1/16" | 9/16" | 5/8" | 3/16" | M-52660 |
| 1 | 5/16" | 1/16" | 7/16" | 5/8" | 1/4" | M-52252 |
| 1 | 5/16" | 1/32" | 7/16" | 5/8" | 7/32" | M-52352 |
| 1 | 5/16" | 3/32" | 7/16" | 19/32" | 11/32" | M-53241 |
| 1 | 5/16" | 3/32" | 15/32" | 3/4" | 11/32" | M-52667 |
| 1 | 5/16" | 3/16" | 17/32" | 3/4" | 9/16" | M-53261 |
| 1 | 5/16" | 1/16" | 17/32" | 3/4" | 7/16" | M-53262 |
| 1 | 5/16" | 1/16" | 5/8" | 7/8" | 5/16" | M-52274 |
| 1 | 5/16" | 3/32" | 11/16" | 7/8" | 11/32" | M-52272 |
| 1 | 5/16" | 3/32" | 3/4" | 1" | 11/32" | M-52125 |
| 1 | 5/16" | 5/32" | 3/4" | 1-1/16" | 1/2" | M-51113 |
| 3 | 5/16" | 1/16" | 13/16" | 1-1/16" | 5/16" | M-51112 |
| 1 | 21/64" | 1/16" | 9/16" | 23/32" | 5/16" | M-50226 |
| 2 | 3/8" | 1/16" | 1/2" | 5/8" | 1/4" | M-50224 |

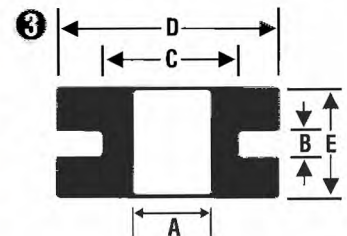
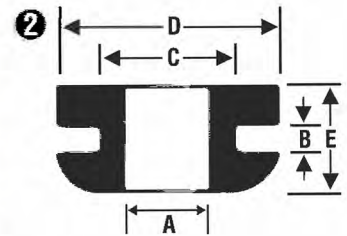
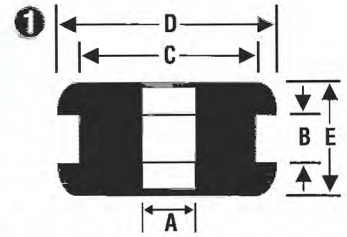

Manufactured Grommets

Our goal is to have your item in stock when you need it, whether it's one of our manufactured parts or one of your custom part requirements.

When you need to see and fit the grommet into your application, most items can be sampled from the list of manufactured grommets for your evaluation. We'll provide the solution to your rubber needs.

**We Offer One Of The
Largest Selections Of
Grommet Molds
In The Industry**

NEOPRENE

(Chloroprene)
Neoprene provides **very good**
resistance to oil, oxygen, ozone, heat,
flame & weather. Temperature range
is -40°F through 225°F.

| SEE DRAWING | A INSIDE DIAMETER | B GROOVE WIDTH | C GROOVE DIAMETER | D OUTSIDE DIAMETER | E OVERALL THICKNESS | PART # |
|-------------|-------------------|----------------|-------------------|--------------------|---------------------|---------|
| 1 | 3/8" | 1/16" | 1/2" | 5/8" | 1/4" | M-50225 |
| 2 | 3/8" | 1/8" | 1/2" | 5/8" | 5/16" | M-50325 |
| 1 | 3/8" | 1/16" | 17/32" | 5/8" | 1/32" | M-52258 |
| 1 | 3/8" | 1/16" | 9/16" | 13/16" | 3/16" | M-50232 |
| 3 | 3/8" | 3/8" | 19/32" | 3/4" | 9/16" | M-52123 |
| 3 | 3/8" | 5/32" | 5/8" | 15/16" | 17/32" | M-52273 |
| 1 | 1/2" | 1/16" | 5/8" | 13/16" | 9/32" | M-50230 |
| 2 | 1/2" | 1/16" | 5/8" | 13/16" | 9/32" | M-50231 |
| 2 | 1/2" | 1/8" | 5/8" | 13/16" | 11/32" | M-50330 |
| 3 | 1/2" | 3/16" | 3/4" | 1" | 7/16" | M-52648 |
| 3 | 1/2" | 1/2" | 13/16" | 1-1/16" | 13/16" | M-52654 |
| 1 | 11/16" | 1/16" | 13/16" | 1-1/16" | 1/4" | M-52301 |
| 1 | 11/16" | 1/8" | 1-3/8" | 1-3/4" | 1/2" | M-52651 |
| 1 | 3/4" | 1/16" | 7/8" | 1-1/8" | 9/32" | M-51117 |
| 1 | 3/4" | 3/32" | 15/16" | 1-1/8" | 5/16" | M-51107 |
| 1 | 13/16" | 3/64" | 15/16" | 1-1/8" | 1/4" | M-51105 |
| 2 | 13/16" | 1/2" | 15/16" | 1-3/16" | 25/32" | M-51224 |
| 1 | 1-1/8" | 3/16" | 1-3/8" | 1-3/4" | 9/16" | M-9327 |
| 1 | 1-1/8" | 1/4" | 1-3/8" | 1-3/4" | 5/8" | M-9328 |
| 1 | 1-1/8" | 5/16" | 1-3/8" | 1-3/4" | 9/16" | M-9329 |
| 1 | 1-1/4" | 1/16" | 1-5/8" | 1-7/8" | 3/8" | M-52929 |



**We Stock Hundreds of Industry-Standard
Parts for Same-Day Shipping**

MILITARY GROMMETS MS-35489-#

Military grommets are available in rubber material that is hot oil & coolant-resistant. Listed below by increasing **Inside Diameter (ID)** are the military grommets that are considered stock items. **Specification: MIL-G-3036**

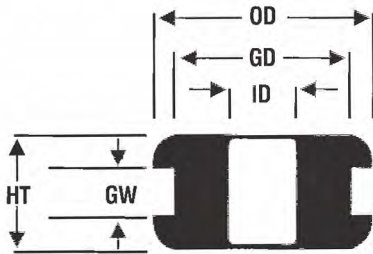

Military Grommets

If your grommet is not in the MS Number, call and we can cross the MS-35489 Series to the AN-931 (Army-Navy Standard Grommets) and also the MS-35490 (Military Standard Split Grommets.)

Ordering grommets under these specifications should include a waiver of Samples Test required by revisions MIL-G-3036. Certifications must be requested at the time of order. We do not charge for these certificates. If testing requirements are unusually strict, laboratory fees may apply.

| Constant Dimensions | | | 1/16" GW | | 1/8" GW | | 3/16" GW | | 1/4" GW | |
|---------------------|---------|----------|----------|------|---------|------|----------|------|---------|------|
| ID | GD | OD | HT | MS # | HT | MS # | HT | MS # | HT | MS # |
| 1/8" | 1/4" | 11/32" | 3/16" | 1 | | | | | | |
| 1/8" | 9/16" | 3/4" | 3/16" | 2 | 1/4" | 31 | 5/16" | 60 | 1/8" | 89 |
| 1/8" | 1" | 1-1/4" | 1/4" | 3 | 5/16" | 32 | 3/8" | 61 | 7/16" | 90 |
| 3/16" | 5/16" | 7/16" | 3/16" | 4 | 1/4" | 33 | 5/16" | 62 | 3/8" | 91 |
| 3/16" | 9/16" | 3/4" | 3/16" | 134 | | | | | | |
| 3/16" | 5/8" | 7/8" | 3/16" | 5 | 1/4" | 34 | 5/16" | 63 | 3/8" | 92 |
| 1/4" | 7/16" | 5/8" | 3/16" | 6 | 1/4" | 35 | 5/16" | 64 | 3/8" | 93 |
| 1/4" | 3/4" | 1" | 1/4" | 7 | 5/16" | 36 | 3/8" | 65 | 7/16" | 94 |
| 1/4" | 1" | 1-1/4" | 1/4" | 8 | 5/16" | 37 | 3/8" | 66 | 7/16" | 95 |
| 5/16" | 9/16" | 13/16" | 5/16" | 9 | 3/8" | 38 | 7/16" | 67 | 1/2" | 96 |
| 5/16" | 3/4" | 1" | 5/16" | 10 | 3/8" | 39 | 7/16" | 68 | 1/2" | 97 |
| 5/16" | 13/16" | 1-1/16" | 5/16" | 118 | 3/8" | 122 | 7/16" | 136 | 1/2" | 130 |
| 3/8" | 5/8" | 7/8" | 5/16" | 11 | 3/8" | 40 | 7/16" | 69 | 1/2" | 98 |
| 3/8" | 1" | 1-1/4" | 1/4" | 12 | 5/16" | 41 | 3/8" | 70 | 7/16" | 99 |
| 7/16" | 11/16" | 15/16" | 5/16" | 13 | 3/8" | 42 | 7/16" | 71 | 1/2" | 100 |
| 1/2" | 13/16" | 1-1/16" | 5/16" | 14 | 3/8" | 43 | 7/16" | 72 | 1/2" | 101 |
| 1/2" | 1-1/4" | 1-1/2" | 1/4" | 15 | 5/16" | 44 | 3/8" | 73 | 7/16" | 102 |
| 9/16" | 13/16" | 1-1/16" | 5/16" | 16 | 3/8" | 45 | 7/16" | 74 | 1/2" | 103 |
| 5/8" | 7/8" | 1-1/8" | 5/16" | 17 | 3/8" | 46 | 7/16" | 75 | 1/2" | 104 |
| 5/8" | 1-1/4" | 1-1/2" | 1/4" | 18 | 5/16" | 47 | 3/8" | 76 | 7/16" | 105 |
| 11/16" | 1 | 1-5/16" | 3/8" | 19 | 7/16" | 48 | 1/2" | 77 | 9/16" | 106 |
| 3/4" | 1-1/16" | 1-3/8" | 3/8" | 20 | 7/16" | 49 | 1/2" | 78 | 9/16" | 107 |
| 3/4" | 1-7/16" | 1-13/16" | 3/8" | 21 | 7/16" | 50 | 1/2" | 79 | 9/16" | 108 |
| 3/4" | 1-1/4" | 1-5/8" | 1/4" | 135 | 5/16" | 123 | 3/8" | 127 | 7/16" | 131 |
| 3/4" | 1-1/4" | 1-5/8" | 1/4" | 119 | | | 3/8" | 126 | | |
| 3/4" | 1-5/8" | 2" | 3/8" | 120 | 7/16" | 124 | 1/2" | 128 | 9/16" | 132 |
| 7/8" | 1-1/4" | 1-5/8" | 7/16" | 22 | 1/2" | 51 | 9/16" | 80 | 5/8" | 109 |
| 7/8" | 1-5/8" | 2" | 7/16" | 121 | 1/2" | 125 | 9/16" | 129 | 5/8" | 133 |
| 1" | 1-3/8" | 1-3/4" | 7/16" | 23 | 1/2" | 52 | 9/16" | 81 | 5/8" | 110 |
| 1" | 1-7/8" | 2-1/4" | 7/16" | 24 | 1/2" | 53 | 9/16" | 82 | 5/8" | 111 |
| 1-1/4" | 2-3/8" | 2-3/4" | 7/16" | 25 | 1/2" | 54 | 9/16" | 83 | 5/8" | 112 |
| 1-1/4" | 2-1/2" | 2-7/8" | 7/16" | 26 | 1/2" | 55 | 9/16" | 84 | 5/8" | 113 |
| 1-1/2" | 1-3/4" | 2-1/8" | 7/16" | 27 | 1/2" | 56 | 9/16" | 85 | 5/8" | 114 |
| 1-1/2" | 2-3/4" | 3-1/4" | 7/16" | 28 | 1/2" | 57 | 9/16" | 86 | 5/8" | 115 |
| 1-3/4" | 3-1/4" | 3-3/4" | 1/2" | 29 | 9/16" | 58 | 5/8" | 87 | 11/16" | 116 |
| 2" | 3-1/2" | 4" | 1/2" | 30 | 9/16" | 59 | 5/8" | 88 | 11/16" | 117 |

RECESSED BUMPERS

Recessed bumpers are available in 60 durometer black SBR. Listed below by increasing **Outside Diameter (A)** are the recessed bumpers that are considered stock items. Check our manufactured recessed bumper section if you cannot find a particular item in this section.

Low minimum orders for stocked parts.



| SEE DRAWING | A OUTSIDE DIAMETER | B RECESS DIAMETER | C BORE DIAMETER | D RECESS DEPTH | E TOTAL HEIGHT | PART # |
|-------------|--------------------------|-------------------------|-----------------------|----------------------|----------------------|-----------|
| 2 | 1/2" | 1/4" | 1/8" | 5/32" | 1/4" | M-1308-W |
| 1 | 1/2" | 1/4" | 1/8" | 7/32" | 7/16" | M-0832-W |
| 2 | 1/2" | 1/4" | 3/32" | 5/32" | 1/4" | M-0852-W |
| 1 | 1/2" | 5/16" | 5/32" | 3/16" | 3/8" | M-6115-W |
| 2 | 5/8" | 5/16" | 5/32" | 5/32" | 7/16" | M-1343-W |
| 1 | 5/8" | .281" | .156" | 1/8" | .281" | M-7270-W |
| 1 | 23/32" | 1/4" | 1/8" | 7/32" | 7/16" | M-0015-W |
| 1 | 3/4" | 5/16" | 1/8" | 1/4" | 3/4" | M-1743-W |
| 1 | 3/4" | 3/8" | 1/8" | 5/32" | 3/8" | M-1388-W |
| 1 | 3/4" | 3/8" | 3/16" | 1/4" | 9/16" | M-0018-W |
| 1 | 13/16" | 15/32" | 1/4" | 7/16" | 13/16" | M-0021-W |
| 2 | 15/16" | 3/8" | 3/16" | 7/32" | 3/8" | M-0253-W |
| 2 | 1" | 1/4" | 1/8" | 7/16" | 13/16" | M-0197-W |
| 2 | 1" | 9/32" | 5/32" | 9/32" | 1/2" | M-0638-W |
| 2 | 1" | 3/8" | 3/16" | 3/16" | 7/16" | M-0698-W |
| 2 | 1" | 5/16" | 5/32" | 5/8" | 1" | M-0023-W |
| 1 | 1" | 1/2" | 7/32" | 1/4" | 1/2" | M-0425-W |
| 1 | 1" | 17/32" | 9/32" | 5/16" | 9/16" | M-0059-W |
| 1 | 1" | 9/16" | 3/16" | 3/8" | 5/8" | M-4114-W |
| 2 | 1-3/32" | 7/16" | 3/16" | 13/32" | 5/8" | M-0068-W |
| 1 | 1-1/4" | 3/8" | 1/4" | 3/4" | 1-7/8" | M-1487-W |
| 1 | 1-1/4" | 3/8" | 1/4" | 3/4" | 1-1/4" | M-1326-W |
| 1 | 1-1/2" | 1/2" | 3/16" | 11/32" | 5/8" | M-1019-W |
| 1 | 1-1/2" | 3/4" | 5/16" | 11/32" | 5/8" | M-1019-2W |
| 1 | 1-1/2" | 3/4" | 1/4" | 3/8" | 1-1/2" | M-7950-W |
| 2 | 2-1/2" | 1-1/8" | 3/8" | 1/2" | 1" | M-0613 |

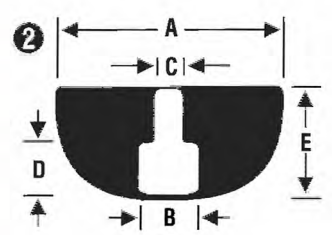
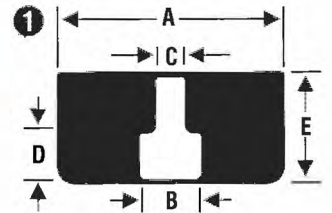

Bumper Benefits

- ▼ Restrict passing vibration from equipment.
- ▼ Stops equipment from sliding or moving.
- ▼ Allows for spacing between bottom of equipment and the ground.

MANUFACTURED RECESSED BUMPERS

Listed below by increasing **Outside Diameter (A)** are manufactured recessed bumpers available in a variety of materials. Minimums for production runs apply; please call for specific information. Normal delivery is 4-6 weeks with a minimum order of \$200.00, but a special 10-working-day expedite is offered on most manufactured parts.

| SEE DRAWING | A OUTSIDE DIAMETER | B RECESS DIAMETER | C BORE DIAMETER | D RECESS DEPTH | E TOTAL HEIGHT | PART # |
|-------------|--------------------------|-------------------------|-----------------------|----------------------|----------------------|-----------|
| 2 | 7/16" | 1/4" | 5/32" | 3/32" | 5/32" | M-12061-W |
| 3 | 15/32" | 17/64" | 1/8" | 1/8" | 1/4" | M-12613-W |
| 2 | 1/2" | 1/4" | 1/8" | 1/8" | 1/4" | M-10207-W |
| 1 | 1/2" | 7/32" | 1/8" | 3/32" | 3/16" | M-12073-W |
| 1 | 1/2" | 15/64" | 1/8" | 3/16" | 1/4" | M-12076-W |
| 1 | 1/2" | 1/4" | 5/32" | 3/16" | 5/16" | M-12071-W |
| 1 | 1/2" | 1/4" | 1/8" | 3/16" | 11/32" | M-12945-W |
| 1 | 1/2" | 1/4" | 5/32" | 3/16" | 1/2" | M-12074-W |
| 1 | 9/16" | 3/8" | 3/16" | 7/32" | 3/8" | M-12813-W |
| 1 | 5/8" | 3/8" | 3/16" | 1/8" | 1/4" | M-12093-W |
| 2 | 5/8" | 1/4" | 3/16" | 3/16" | 5/16" | M-12081-W |
| 2 | 5/8" | 1/4" | 1/8" | 3/16" | 5/16" | M-12088-W |
| 2 | 5/8" | 1/4" | 1/8" | 3/16" | 3/8" | M-12806-W |
| 3 | 5/8" | 5/16" | 5/32" | 1/4" | 1/2" | M-12082-W |
| 3 | 5/8" | 5/16" | 5/32" | 5/16" | 5/8" | M-12803-W |
| 1 | 5/8" | 11/32" | 11/64" | 15/32" | 3/4" | M-12081-W |
| 1 | 5/8" | 5/16" | 5/32" | 5/16" | 3/4" | M-12804-W |
| 1 | 5/8" | 5/16" | 11/64" | 5/16" | 3/4" | M-12805-W |
| 1 | 5/8" | 5/16" | 5/32" | 1/4" | 3/4" | M-12807-W |
| 1 | 11/16" | 1/4" | 1/8" | 3/16" | 7/16" | M-12083-W |
| 3 | 3/4" | 1/4" | 1/8" | 5/32" | 9/32" | M-12087-W |
| 1 | 3/4" | 3/8" | 3/16" | 1/8" | 9/32" | M-12092-W |
| 3 | 3/4" | 11/32" | 1/8" | 3/16" | 19/64" | M-12184-W |
| 2 | 3/4" | 5/16" | 5/32" | 3/16" | 3/8" | M-12085-W |
| 3 | 3/4" | 3/8" | 3/16" | 1/4" | 1/2" | M-12089-W |
| 1 | 3/4" | 3/8" | 9/64" | 1/4" | 1/2" | M-12091-W |
| 3 | 3/4" | 3/8" | 3/16" | 1/4" | 9/16" | M-12950-W |
| 3 | 3/4" | 7/16" | 3/16" | 1/4" | 7/16" | M-12084-W |
| 3 | 7/8" | 3/8" | 3/16" | 3/16" | 13/32" | M-12198-W |
| 3 | 15/16" | 3/8" | 1/8" | 1/4" | 1/2" | M-12094-W |
| 3 | 15/16" | 7/16" | 7/32" | 7/16" | 5/8" | M-12096-W |
| 1 | 15/16" | 3/8" | 3/16" | 9/16" | 15/16" | M-12811-W |
| 3 | 1" | 3/8" | 3/16" | 1/4" | 1/2" | M-12197-W |
| 1 | 1" | 3/8" | 7/32" | 9/16" | 1" | M-12098-W |
| 2 | 1" | 5/16" | 5/32" | 5/8" | 1" | M-12580-W |
| 1 | 1" | 1/4" | 1/8" | 5/8" | 1-1/4" | M-12812-W |
| 2 | 1" | 5/16" | 5/32" | 5/8" | 1-1/2" | M-12099-W |
| 3 | 1" | 5/16" | 5/32" | 1-3/8" | 2-1/4" | M-12199-W |
| 2 | 1-11/16" | 3/4" | 1/4" | 3/8" | 5/8" | M-12808-W |

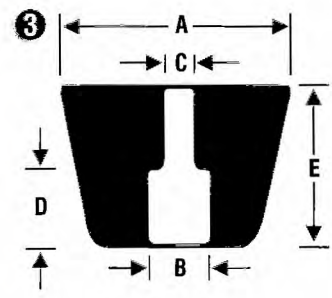
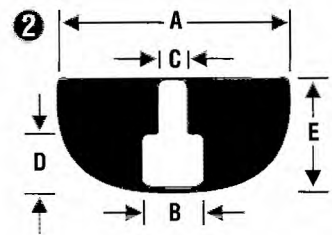
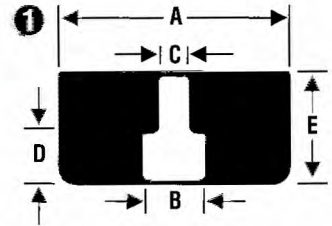

We Offer One Of The
Largest Selections
Of Bumper Molds
In The Industry

STEM BUMPERS

Stem bumpers are available in 60 durometer black SBR. Listed below by increasing **Head Height (A)** are the stem bumpers that are considered stock items. Check our manufactured stem bumper section if you cannot find a particular item in this section.

Low minimum orders for stocked parts.



| SEE DRAWING | A HEAD HEIGHT | B HEAD DIAMETER | C STEM DIAMETER | D STEM LENGTH | E TOTAL HEIGHT | PART # |
|-------------|---------------|-----------------|-----------------|---------------|----------------|----------|
| 1 | 1/16" | 1/2" | 3/16" | 1/4" | 5/16" | M-0011-F |
| 1 | 1/16" | 3/8" | 7/32" | 1/4" | 5/16" | M-0783 |
| 2 | 1/8" | 5/16" | 3/16" | 3/16" | 5/16" | M-0713 |
| 2 | 1/8" | 3/8" | 3/16" | 3/16" | 5/16" | M-0012 |
| 1 | 1/8" | 1/2" | 1/4" | 1/4" | 3/8" | M-26171 |
| 1 | 3/16" | 1/2" | 3/8" | 1/4" | 7/16" | M-26081 |
| 1 | 1/4" | 5/8" | 3/8" | 3/8" | 5/8" | M-26095 |
| 1 | 1/4" | 7/8" | 5/8" | 7/16" | 5/8" | M-1647 |
| 1 | 1/4" | 1-1/4" | 3/4" | 11/16" | 15/16" | M-0242 |
| 2 | 5/16" | 5/8" | 5/16" | 1/4" | 9/16" | M-0868 |
| 1 | 3/8" | 11/16" | 1/2" | 1/2" | 7/8" | M-0158 |
| 2 | 3/8" | 3/4" | 3/8" | 3/8" | 3/4" | M-1111 |
| 2 | 3/8" | 13/16" | 9/16" | 5/8" | 1" | M-26121 |
| 1 | 3/8" | 13/16" | 5/8" | 1/2" | 7/8" | M-0210 |
| 2 | 3/8" | 7/8" | 1/2" | 15/32" | 27/32" | M-1006 |
| 1 | 7/16" | 5/8" | 7/16" | 1/2" | 15/16" | M-26088 |

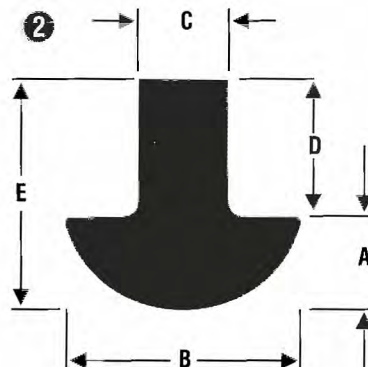
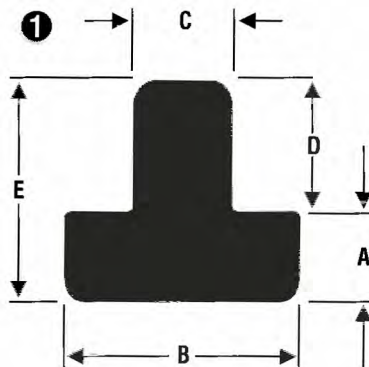

Stem Bumpers

Stem bumpers provide an economical way to add bumpers to your product. Stem bumpers require no additional fasteners, and are easily installed by pressing in.

Stem Bumper Benefits

- ▼ Allows for spacing and ventilation.
- ▼ Can be used as a stop cushion.
- ▼ Restricts the passing of vibration from equipment.
- ▼ Stops equipment from sliding and moving.
- ▼ Protects surfaces that equipment is placed on.

MANUFACTURED STEM BUMPERS

Listed below by increasing **Head Height (A)** are manufactured stem bumpers available in a variety of materials. Minimums for production runs apply; please call for specific information. Normal delivery is 4-6 weeks with a minimum order of \$200.00, but a special 10-working-day expedite is offered on most manufactured parts.

| SEE DRAWING | A HEAD HEIGHT | B HEAD DIAMETER | C STEM DIAMETER | D STEM LENGTH | E TOTAL HEIGHT | PART # |
|-------------|---------------|-----------------|-----------------|---------------|----------------|---------|
| 1 | 1/32" | 1/2" | 3/16" | 7/32" | 1/4" | M-26135 |
| 1 | 1/16" | 1/4" | 11/64" | 1/8" | 3/16" | M-26012 |
| 1 | 1/16" | 1/2" | 3/8" | 1/4" | 5/16" | M-26072 |
| 1 | 1/16" | 15/32" | 3/8" | 3/8" | 7/16" | M-26086 |
| 1 | 5/64" | 3/8" | 15/64" | 3/16" | 17/64" | M-26045 |
| 1 | 5/64" | 1/2" | 3/16" | 1/4" | 21/64" | M-26137 |
| 1 | 5/64" | 1/2" | 1/4" | 5/16" | 25/64" | M-26172 |
| 1 | 3/32" | 1/2" | 1/4" | 3/16" | 9/32" | M-26075 |
| 1 | 3/32" | 1/2" | 3/16" | 1/4" | 11/32" | M-26174 |
| 1 | 7/64" | 5/8" | 17/64" | 15/64" | 11/32" | M-22643 |
| 2 | 1/8" | 1/4" | 1/8" | 3/32" | 7/32" | M-20601 |
| 1 | 1/8" | 1/2" | 1/4" | .336" | 15/32" | M-26071 |
| 1 | 1/8" | 1/2" | 5/16" | 5/16" | 7/16" | M-20607 |
| 2 | 1/8" | 1/4" | 1/8" | 3/16" | 5/16" | M-26011 |
| 2 | 1/8" | 1/2" | 19/64" | 5/16" | 7/16" | M-26079 |
| 1 | 1/8" | 7/16" | 9/32" | 7/32" | 11/32" | M-26084 |
| 1 | 1/8" | 9/16" | 7/16" | 19/64" | 27/64" | M-26097 |
| 1 | 9/64" | 15/32" | 5/16" | 5/16" | 29/64" | M-26076 |
| 2 | 5/32" | 3/8" | 9/32" | 1/4" | 13/32" | M-20605 |
| 2 | 5/32" | 9/16" | 7/16" | 1/8" | 9/32" | M-26035 |
| 1 | 5/32" | 3/8" | 3/16" | 3/16" | 11/32" | M-26046 |
| 2 | 5/32" | 3/8" | 1/4" | 9/32" | 7/16" | M-26051 |
| 1 | 5/32" | 7/16" | 1/4" | 3/16" | 11/32" | M-26087 |
| 2 | 11/64" | 27/64" | 1/4" | 1/4" | 22/64" | M-26065 |
| 2 | 3/16" | 1/2" | 1/4" | 1/8" | 5/16" | M-20603 |
| 2 | 3/16" | 7/16" | 3/16" | 1/8" | 5/16" | M-20606 |
| 2 | 3/16" | 7/16" | 5/16" | 5/16" | 1/2" | M-20608 |
| 2 | 3/16" | 1/2" | 13/64" | 1/8" | 5/16" | M-26031 |
| 2 | 3/16" | 7/16" | 7/32" | 1/8" | 5/16" | M-26061 |
| 2 | 3/16" | 7/16" | 1/4" | 1/4" | 7/16" | M-26062 |
| 1 | 3/16" | 1/2" | 3/8" | 3/16" | 3/8" | M-26082 |
| 1 | 3/16" | 7/16" | 5/16" | 1/8" | 5/16" | M-26083 |
| 1 | 3/16" | 7/8" | 1/2" | 3/8" | 9/16" | M-22652 |
| 1 | 7/32" | 5/8" | 7/16" | 1/2" | 23/32" | M-26180 |
| 2 | 1/4" | 11/16" | 17/32" | 11/32" | 19/32" | M-20610 |
| 3 | 1/4" | 15/32" | 3/8" | 7/16" | 11/16" | M-20671 |
| 2 | 1/4" | 1/2" | 7/16" | 7/16" | 11/16" | M-26032 |
| 2 | 1/4" | 1/2" | 13/32" | 7/16" | 11/16" | M-26033 |
| 3 | 9/32" | 3/8" | 3/16" | 9/32" | 9/16" | M-22656 |
| 2 | 9/32" | 5/8" | 7/16" | 7/16" | 23/32" | M-20613 |
| 3 | 21/64" | 1/2" | 3/16" | 5/16" | 41/64" | M-26080 |
| 2 | 3/8" | 13/16" | 11/16" | 1/2" | 7/8" | M-20612 |

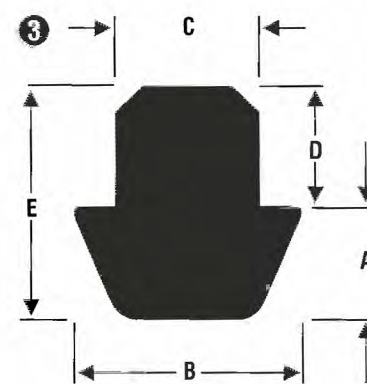
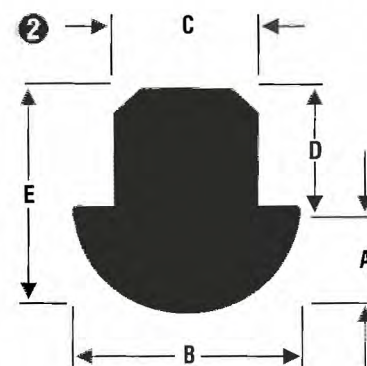
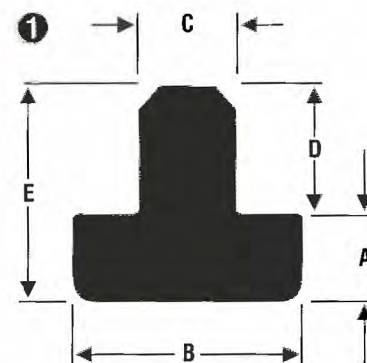

**Samples Available
For Your Evaluation**

**We Offer One Of The
Largest Selections Of
Stem Bumper Molds
In The Industry**

| SEE DRAWING | A HEAD HEIGHT | B HEAD DIAMETER | C STEM DIAMETER | D STEM LENGTH | E TOTAL HEIGHT | PART # |
|-------------|---------------|-----------------|-----------------|---------------|----------------|---------|
| 3 | 3/8" | 11/16" | 17/32" | 3/8" | 3/4" | M-26101 |
| 2 | 3/8" | 13/16" | 9/16" | 5/8" | 1" | M-26121 |
| 2 | 3/8" | 13/16" | 21/32" | 1/2" | 7/8" | M-26122 |
| 1 | 7/16" | 7/16" | 5/16" | 1/2" | 15/16" | M-26089 |
| 1 | 15/32" | 7/16" | 1/4" | 1/2" | 31/32" | M-26167 |
| 3 | 1/2" | 5/8" | 5/16" | 7/16" | 15/16" | M-26096 |

NITRILE

(Butadiene Acrylonitrile)
Nitrile is used primarily for applications requiring **excellent resistance to petroleum oils and gasoline**. Nitrile **also has excellent resistance to mineral & vegetable oils**. Nitrile should not be used with solvents such as acetone, methylethyl ketone or other ketones.

Manufactured Stem Bumpers

- ▼ Manufactured stem bumpers save time and money by eliminating the need for new mold and tooling costs.
- ▼ If you can't find the part you are looking for in this catalog, please call. We have the capability to make any part you need.
- ▼ When you need help in determining the type of rubber to use, call us and we'll gladly help you find the optimal material for your application.
- ▼ Our goal is to have it in stock when you need it, whether it's our manufactured parts or one of your custom requirements.
- ▼ If the stem bumper you need is one of our manufactured parts, let us know and we'll keep it in stock and ship to your specific schedule.

**Let Us Know Your Requirements and We
Can Add It To Our Stock for Same-Day Shipping**



CATCH BUMPERS

Catch bumpers are available in 60 durometer black SBR. Listed below by increasing **Head Height (A)** are the catch bumpers that are considered stock items. Check our manufactured catch bumper section if you cannot find a particular item in this section. **Low minimum orders for stocked parts.**



| SEE DRAWING | A HEAD HEIGHT | B HEAD DIAMETER | C STEM DIAMETER | D CATCH DIAMETER | E GROOVE WIDTH | F TOTAL HEIGHT | PART # |
|-------------|---------------|-----------------|-----------------|------------------|----------------|----------------|----------|
| 1 | 1/16" | 1/2" | 1/4" | 1/2" | 1/16" | 19/64" | M-32682 |
| 3 | 3/32" | 3/8" | 5/32" | 7/32" | 1/16" | 17/64" | M-1257 |
| 1 | 3/32" | 1/2" | 3/16" | 1/4" | 1/16" | 11/32" | M-1178-1 |
| 1 | 3/32" | 7/16" | 1/4" | 5/16" | 3/64" | 17/64" | M-0716 |
| 1 | 1/8" | 3/8" | 3/16" | 1/4" | 1/16" | 5/16" | M-34061 |
| 1 | 1/8" | 3/8" | 3/16" | 1/4" | 3/32" | 11/32" | M-34161 |
| 3 | 1/8" | 9/16" | 1/4" | 11/32" | 1/8" | 3/16" | M-0711 |
| 1 | 1/8" | 5/16" | 3/16" | 1/4" | 3/64" | 17/64" | M-0785 |
| 3 | 1/8" | 9/16" | 9/32" | 3/8" | 5/64" | 23/64" | M-1138 |
| 2 | 1/8" | 3/8" | 3/16" | 1/4" | 1/32" | 3/8" | M-1439 |
| 2 | 5/32" | 1/2" | 1/4" | 5/16" | 1/16" | 11/32" | M-1561 |
| 1 | 5/32" | 1/2" | 3/16" | 1/4" | 1/16" | 9/32" | M-1178-2 |
| 3 | 5/32" | 9/16" | 11/32" | 13/32" | 1/16" | 9/32" | M-0740 |
| 2 | 11/64" | 1/2" | 3/16" | 5/16" | 3/64" | 13/32" | M-2328 |
| 1 | 3/16" | 1/2" | 3/16" | 1/4" | 1/16" | 7/16" | M-34171 |
| 1 | 3/16" | 3/4" | 11/32" | 15/32" | 1/8" | 7/16" | M-34270 |
| 1 | 7/32" | 3/8" | 1/4" | 5/16" | 1/16" | 13/32" | M-34262 |
| 1 | 1/4" | 5/8" | 5/16" | 3/8" | 3/32" | 15/32" | M-0778 |
| 3 | 1/4" | 1/2" | 1/4" | 5/16" | 1/16" | 7/16" | M-0734 |
| 3 | 5/16" | 1" | 1/2" | 11/16" | 3/16" | 11/16" | M-2250 |
| 1 | 5/16" | 1/2" | 13/64" | 1/4" | 1/16" | 9/16" | M-34075 |
| 3 | 11/32" | 5/8" | 9/32" | 7/16" | 1/8" | 41/64" | M-1422 |
| 1 | 3/8" | 1/2" | 13/64" | 1/4" | 1/16" | 7/8" | M-32663 |
| 2 | 3/8" | 1/2" | 1/4" | 3/8" | 1/8" | 15/16" | M-32688 |
| 1 | 1/2" | 3/8" | 1/4" | 11/32" | 1/16" | 21/32" | M-34264 |

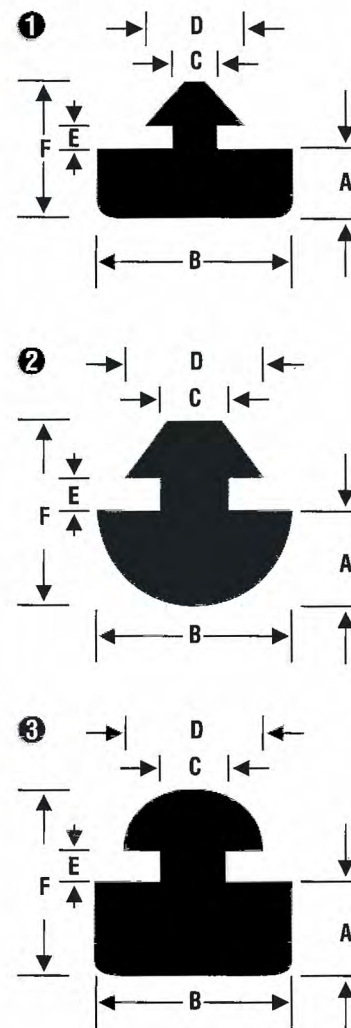

Stock Catch Bumpers

Catch bumpers provide an economical way to add bumpers to your product. These bumpers require no additional fasteners, and are easily installed by inserting the catch portion in the appropriate size hole.

MANUFACTURED CATCH BUMPERS

Listed below by increasing **Head Height (A)** are manufactured catch bumpers available in a variety of materials. Minimums for production runs apply; please call for specific information. Normal delivery is 4-6 weeks with a minimum order of \$200.00, but a special 10-working-day expedite is offered on most manufactured parts.

| SEE DRAWING | A HEAD HEIGHT | B HEAD DIAMETER | C STEM DIAMETER | D CATCH DIAMETER | E GROOVE WIDTH | F TOTAL HEIGHT | PART # |
|-------------|---------------|-----------------|-----------------|------------------|----------------|----------------|---------|
| 3 | 3/64" | 5/16" | 1/8" | 3/16" | 1/32" | 3/16" | M-33161 |
| 1 | 1/16" | 17/32" | 15/64" | 19/64" | 3/64" | 17/64" | M-33058 |
| 1 | 1/16" | 1/2" | 9/32" | 3/8" | 3/64" | 17/64" | M-33171 |
| 1 | 1/16" | 1/2" | 1/4" | 1/2" | 1/16" | 19/64" | M-32682 |
| 3 | 1/16" | 5/16" | 1/8" | 3/16" | 1/16" | 7/32" | M-33188 |
| 1 | 1/16" | 9/16" | 9/32" | 3/8" | 1/16" | 1/4" | M-34081 |
| 1 | 1/16" | 5/8" | 3/16" | 7/32" | 1/32" | 9/32" | M-34182 |
| 1 | 3/32" | 3/8" | 1/4" | 5/16" | 3/64" | 1/4" | M-33062 |
| 2 | 3/32" | 7/16" | 15/64" | 19/64" | 3/64" | 19/64" | M-33064 |
| 3 | 3/32" | 7/16" | 3/16" | 1/4" | 5/64" | 17/64" | M-34068 |
| 1 | 3/32" | 7/16" | 1/4" | 5/16" | 3/64" | 17/64" | M-32944 |
| 1 | 3/32" | 3/8" | 5/32" | 1/4" | 1/16" | 17/64" | M-34288 |
| 2 | 7/64" | 5/16" | 3/16" | 15/64" | 1/16" | 15/32" | M-32659 |
| 1 | 7/64" | 17/32" | 15/64" | 19/64" | 3/64" | 5/16" | M-33056 |
| 1 | 1/8" | 3/8" | 3/16" | 1/4" | 3/64" | 9/32" | M-33061 |
| 2 | 1/8" | 7/16" | 1/4" | 5/16" | 1/16" | 11/32" | M-33065 |
| 1 | 1/8" | 1/2" | 9/32" | 3/8" | 3/64" | 21/64" | M-33072 |
| 1 | 1/8" | 3/8" | 1/4" | 9/32" | 3/64" | 13/32" | M-33176 |
| 1 | 1/8" | 3/8" | 1/4" | 19/64" | 1/16" | 13/32" | M-33178 |
| 1 | 1/8" | 3/8" | 3/16" | 1/4" | 1/16" | 5/16" | M-34601 |
| 1 | 1/8" | 3/8" | 1/4" | 5/16" | 1/16" | 5/16" | M-34062 |
| 2 | 1/8" | 3/8" | 5/32" | 1/4" | 1/16" | 1/4" | M-34063 |
| 2 | 1/8" | 7/16" | 15/64" | 9/32" | 3/64" | 21/64" | M-34067 |
| 1 | 1/8" | 1/2" | 3/16" | 1/4" | 1/16" | 3/8" | M-34071 |
| 1 | 1/8" | 1/2" | 1/4" | 3/8" | 1/16" | 13/32" | M-34078 |
| 1 | 1/8" | 3/8" | 3/16" | 1/4" | 3/32" | 11/32" | M-34161 |
| 3 | 1/8" | 9/16" | 9/32" | 3/8" | 5/64" | 23/64" | M-32938 |
| 1 | 1/8" | 1/2" | 1/4" | 5/16" | 3/64" | 5/16" | M-34168 |
| 1 | 1/8" | 5/8" | 5/16" | 7/16" | 3/64" | 5/16" | M-34187 |
| 1 | 1/8" | 1/2" | 3/8" | 33/64" | 1/16" | 5/16" | M-34193 |
| 3 | 1/8" | 1/2" | 1/4" | 5/16" | 1/8" | 11/32" | M-32949 |
| 1 | 1/8" | 1/2" | 3/16" | 1/4" | 3/32" | 13/32" | M-34271 |
| 3 | 1/8" | 17/32" | 1/4" | 11/32" | 1/8" | 13/32" | M-32959 |
| 4 | 9/64" | 9/16" | 1/4" | 3/8" | 1/16" | 9/16" | M-34283 |
| 4 | 5/32" | 1/2" | 1/4" | 11/32" | 1/8" | 1-1/8" | M-32633 |
| 2 | 5/32" | 5/16" | 3/16" | 1/4" | 1/32" | 9/16" | M-33167 |
| 4 | 5/32" | 1/2" | 1/4" | 5/16" | 3/32" | 9/16" | M-34077 |
| 1 | 5/32" | 9/16" | 11/32" | 27/64" | 1/16" | 5/16" | M-34085 |
| 1 | 5/32" | 3/8" | 1/4" | 5/16" | 1/16" | 11/32" | M-34162 |
| 4 | 5/32" | 1/2" | 1/4" | 5/16" | 1/32" | 1/2" | M-34177 |
| 4 | 5/32" | 5/8" | 19/64" | 3/8" | 1/8" | 1-1/8" | M-34188 |

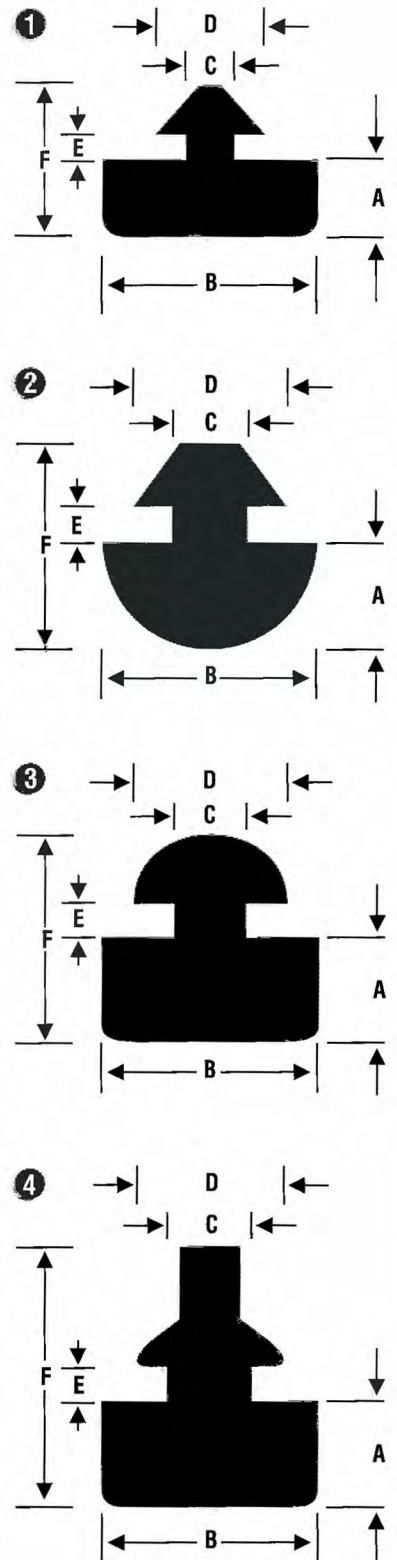

MANUFACTURED CATCH BUMPERS, CONTINUED

| SEE DRAWING | A HEAD HEIGHT | B HEAD DIAMETER | C STEM DIAMETER | D CATCH DIAMETER | E GROOVE WIDTH | F TOTAL HEIGHT | PART # |
|-------------|---------------|-----------------|-----------------|------------------|----------------|----------------|---------|
| 4 | 5/32" | 1/2" | 11/64" | 1/4" | 1/32" | 5/8" | M-34277 |
| 3 | 5/32" | 1/2" | 1/4" | 5/16" | 1/16" | 11/32" | M-34286 |
| 2 | 5/32" | 13/16" | 1/4" | 5/16" | 1/16" | 11/32" | M-36112 |
| 1 | 3/16" | 7/16" | 1/4" | 5/16" | 3/64" | 23/64" | M-33063 |
| 1 | 3/16" | 1/2" | 9/32" | 3/8" | 3/64" | 25/64" | M-33071 |
| 4 | 3/16" | 1/4" | 1/8" | 7/32" | 3/64" | 9/16" | M-33165 |
| 1 | 3/16" | 1/2" | 9/32" | 3/8" | 5/64" | 27/64" | M-33181 |
| 4 | 3/16" | 3/8" | 13/64" | 17/64" | 3/64" | 11/16" | M-33185 |
| 3 | 3/16" | 7/16" | 1/4" | 5/16" | 1/8" | 7/16" | M-33263 |
| 3 | 3/16" | 1/2" | 3/16" | 1/4" | 1/16" | 3/8" | M-34072 |
| 2 | 3/16" | 1/2" | 1/4" | 5/16" | 1/16" | 7/16" | M-34076 |
| 1 | 3/16" | 3/8" | 17/64" | 11/32" | 1/32" | 3/8" | M-34163 |
| 1 | 3/16" | 1/2" | 3/16" | 1/4" | 1/16" | 7/16" | M-34171 |
| 1 | 3/16" | 1/2" | 1/4" | 5/16" | 1/32" | 7/16" | M-34176 |
| 1 | 3/16" | 3/4" | 11/32" | 15/32" | 1/8" | 7/16" | M-34270 |
| 4 | 3/16" | 15/32" | 1/4" | 5/16" | 1/16" | 7/8" | M-34280 |
| 1 | 3/16" | 3/4" | 1/4" | 3/8" | 1/16" | 3/4" | M-36113 |
| 3 | 13/64" | 3/8" | 3/16" | 1/4" | 1/32" | 21/64" | M-33187 |
| 1 | 7/32" | 3/8" | 15/64" | 19/64" | 1/16" | 15/32" | M-33168 |
| 1 | 7/32" | 3/8" | 1/4" | 5/16" | 1/16" | 13/32" | M-34262 |
| 2 | 15/64" | 1/2" | 1/4" | 11/32" | 1/32" | 25/64" | M-33073 |
| 1 | 15/64" | 1/2" | 1/4" | 23/64" | 1/32" | 37/64" | M-34179 |
| 3 | 1/4" | 1/2" | 1/4" | 5/16" | 1/16" | 7/16" | M-32940 |
| 1 | 1/4" | 7/8" | 5/16" | 13/32" | 5/64" | 1/2" | M-30611 |
| 1 | 1/4" | 3/8" | 5/32" | 7/32" | 1/32" | 7/16" | M-33068 |
| 1 | 1/4" | 5/8" | 5/16" | 25/64" | 3/64" | 15/32" | M-34088 |
| 4 | 1/4" | 1/2" | 1/4" | 3/8" | 1/8" | 13/16" | M-32931 |
| 1 | 1/4" | 1/2" | 9/32" | 13/32" | 3/64" | 27/64" | M-34167 |
| 1 | 1/4" | 1/2" | 1/4" | 11/32" | 5/64" | 53/64" | M-32661 |
| 4 | 1/4" | 15/32" | 1/4" | 3/8" | 3/64" | 27/32" | M-34180 |
| 1 | 1/4" | 7/8" | 5/16" | 13/32" | 9/32" | 45/64" | M-36111 |
| 1 | 19/64" | 1/2" | 1/4" | 5/16" | 1/16" | 7/16" | M-34165 |
| 1 | 5/16" | 7/16" | 5/16" | 13/32" | 1/32" | 5/8" | M-33075 |
| 1 | 5/16" | 1/2" | 13/64" | 1/4" | 1/16" | 9/16" | M-34075 |
| 4 | 5/16" | 1/2" | 1/4" | 3/8" | 1/8" | 61/64" | M-34181 |
| 1 | 5/16" | 1/2" | 1/4" | 5/16" | 9/64" | 9/16" | M-34287 |
| 4 | 3/8" | 5/16" | 1/8" | 3/16" | 1/16" | 11/16" | M-33186 |
| 1 | 3/8" | 1/2" | 13/64" | 1/4" | 1/16" | 7/8" | M-32663 |
| 2 | 3/8" | 1/2" | 1/4" | 3/8" | 1/8" | 15/16" | M-32688 |
| 1 | 3/8" | 5/8" | 15/64" | 5/16" | 1/8" | 3/4" | M-34191 |
| 1 | 3/8" | 9/16" | 1/4" | 11/32" | 3/64" | 11/16" | M-32601 |

**We Offer One Of The
Largest Selections Of
Catch Bumpers Molds
In The Industry**



Manufactured Catch Bumpers

Various materials and durometers available.

Fast turnaround on manufactured parts.

Use the correct material for your job, and don't over or under buy.

Call for our quantity discounts.

Our job is to have it in stock when you need it.

If you have a question about rubber you need answered, call us...we're here to help.

MANUFACTURED CATCH BUMPERS, CONTINUED

**Blanket Orders
Accepted With Firm
Release Dates,
Allowing For Larger
Quantity Discounts**

| SEE DRAWING | A HEAD HEIGHT | B HEAD DIAMETER | C STEM DIAMETER | D CATCH DIAMETER | E GROOVE WIDTH | F TOTAL HEIGHT | PART # |
|-------------|---------------|-----------------|-----------------|------------------|----------------|----------------|---------|
| 4 | 13/32" | 7/8" | 1/4" | 13/32" | 5/64" | 1-1/32" | M-31165 |
| 1 | 1/2" | 3/8" | 1/4" | 11/32" | 1/16" | 21/32" | M-34264 |
| 1 | 1/2" | 3/8" | 17/64" | 11/32" | 1/32" | 5/8" | M-34164 |
| 3 | 1/2" | 7/16" | 1/4" | 11/32" | 1/32" | 21/32" | M-34166 |
| 1 | 9/16" | 1/2" | 1/4" | 23/64" | 1/16" | 29/32" | M-34079 |
| 1 | 11/16" | 1/2" | 1/4" | 11/32" | 1/16" | 1-1/64" | M-34284 |
| 2 | 11/16" | 1/2" | 1/4" | 3/8" | 1/8" | 1-1/4" | M-32689 |

BUNA-S

? A term referring to SBR
(*Styrene-Butadiene*). SBR offers **excellent tear strength, high resilience & tensile strength, good abrasion resistance and a temperature range of -60°F through 180°F.**

Note: SBR should not be used in a chemical or fuel environment.

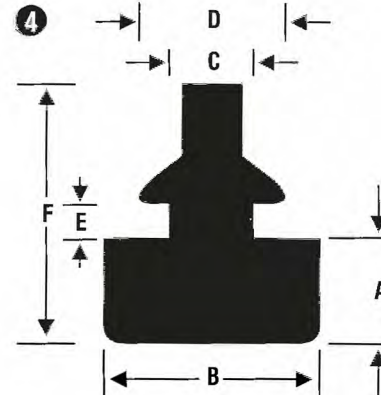
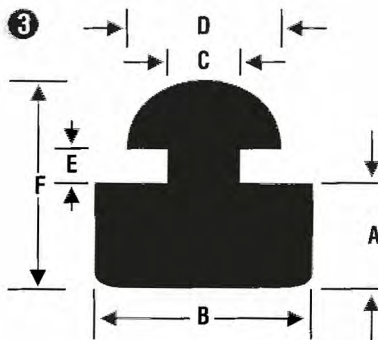
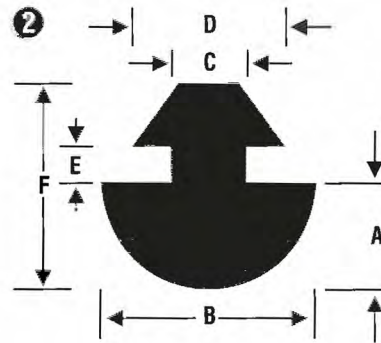
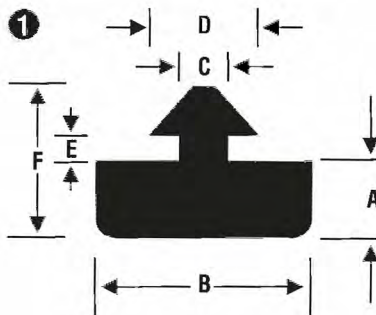

BUMPER PADS

Bumper pads are available in 60 durometer black SBR. **Low minimum orders for stocked parts.** (W) refers to a washer molded into the part.

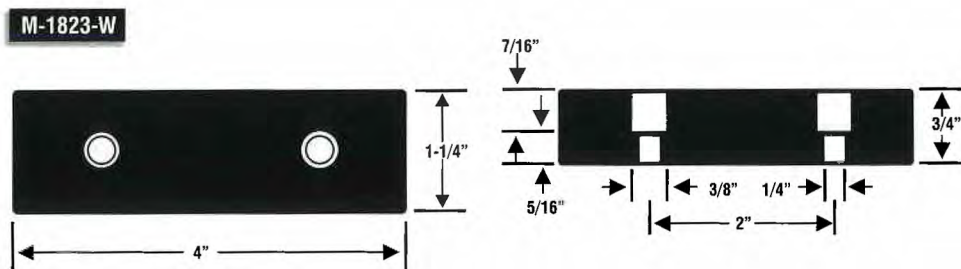
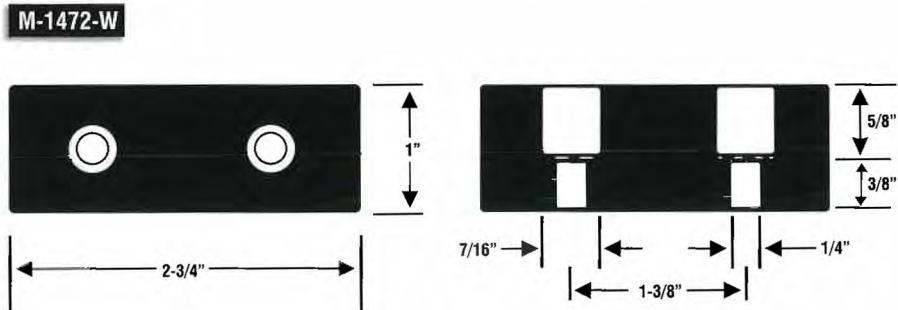
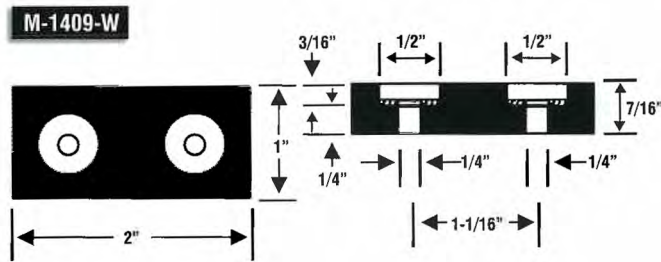
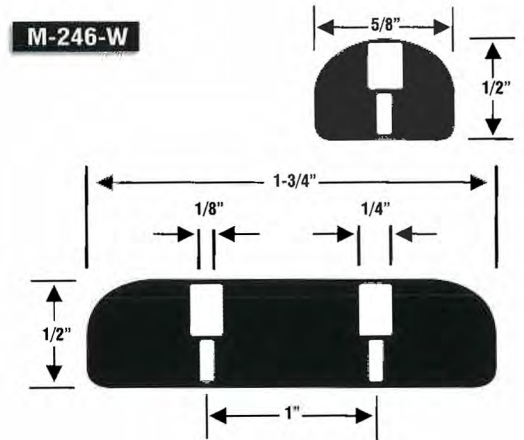
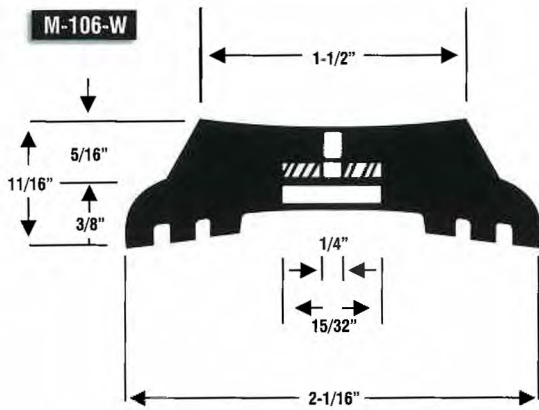

SCREW BUMPERS

Screw bumpers are available in 60 durometer black SBR. Low minimum orders for stocked parts.

M-1155-D Knurled Stud

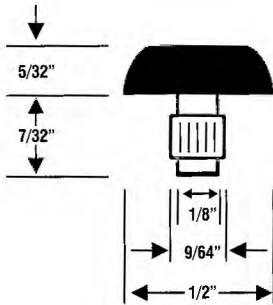

M-827-D Knurled Stud

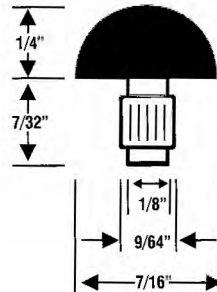

M-827-S 6/32 Machine Screw

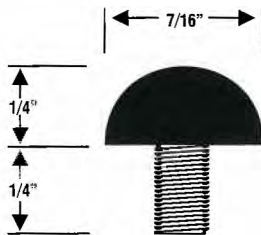

M-422-A 10/32 Machine Screw

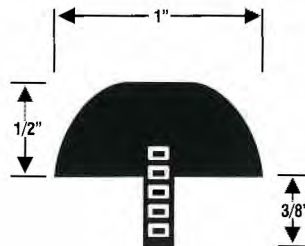

M-868-2 8/32 Insert

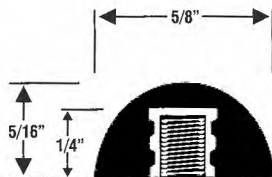

TRUCK BUMPERS

Truck bumpers are available in the configurations shown below. **Material:** 70 durometer Black SBR. **Low minimum orders for stocked parts.**

M-6905

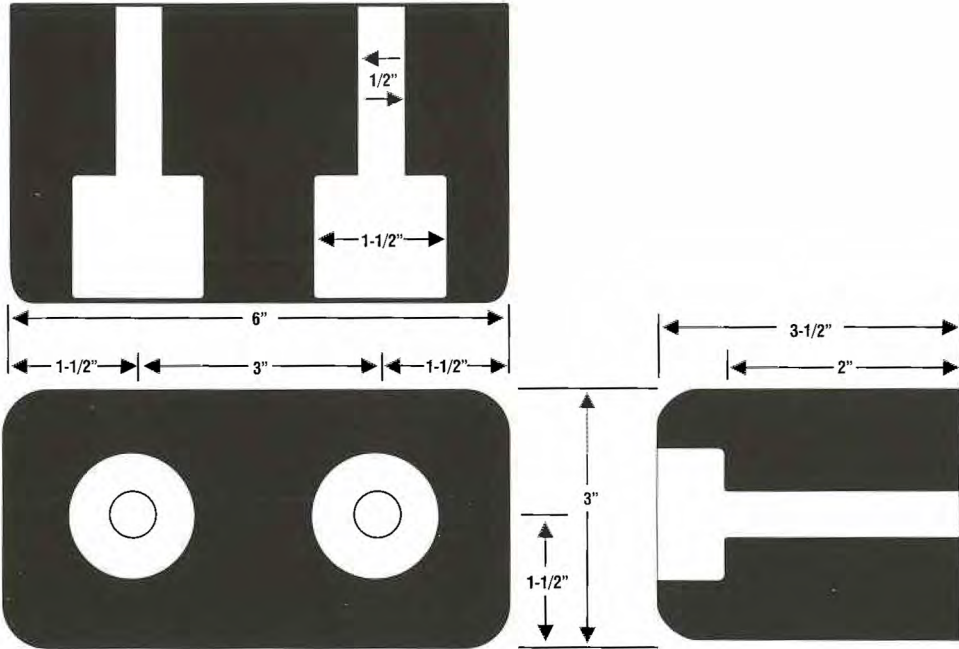

M-7265

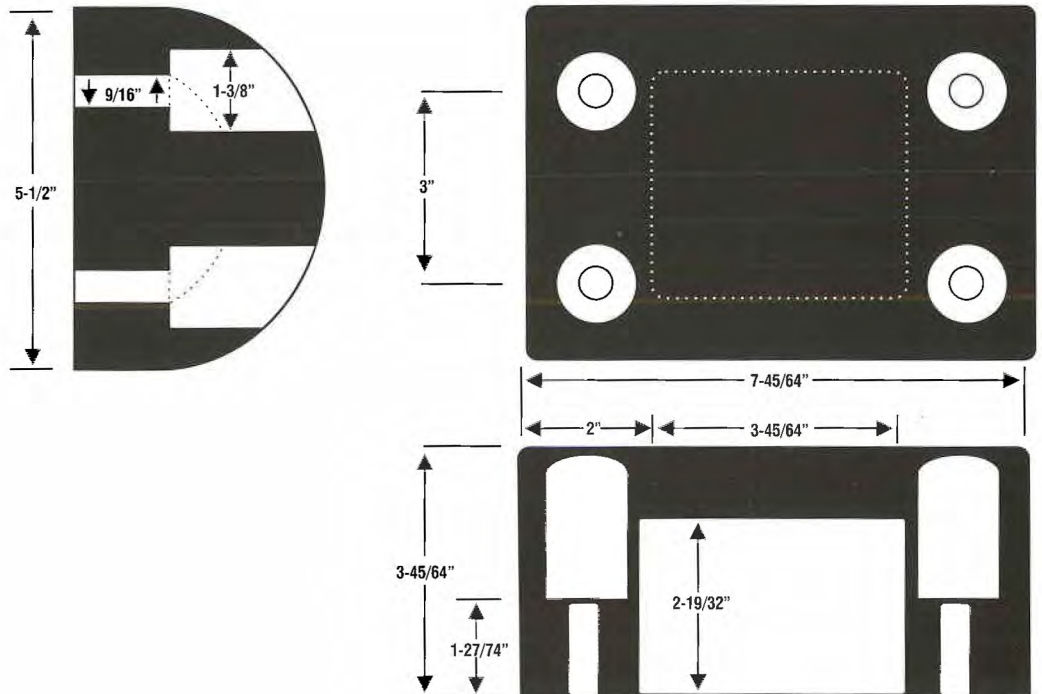

MOLDED PARTS

Molded stock parts are available in 60 durometer black SBR. **Low minimum orders for stocked parts.**

M-2196-S Split Web

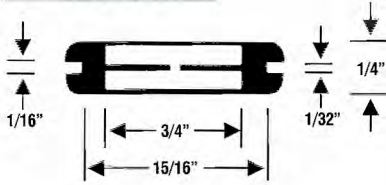

M-2196-W Solid Web

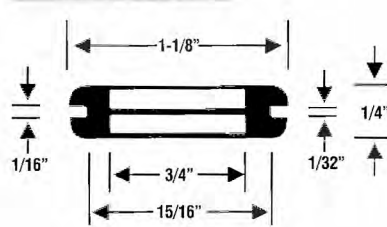

M-2215

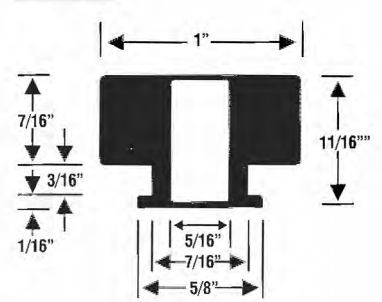

M-5436

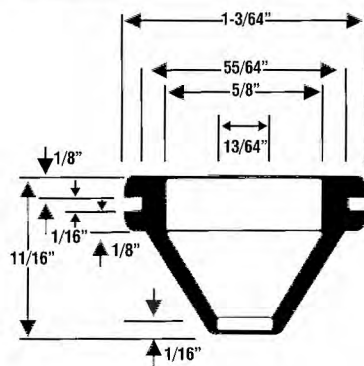

M-383 Square Tip

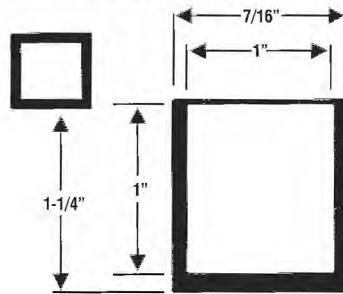

M-1172

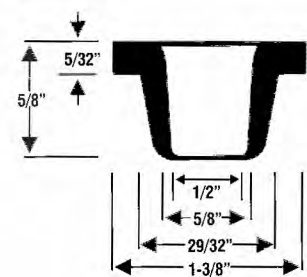

M-693

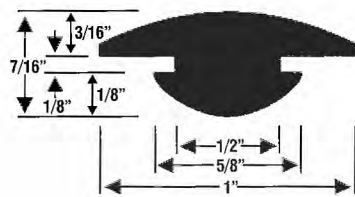

M-0209 Rubber Threads

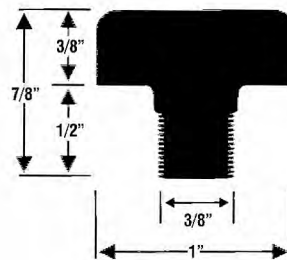

M-2374

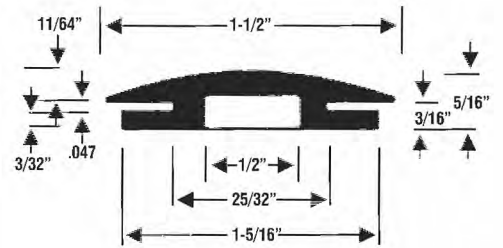

M-2376

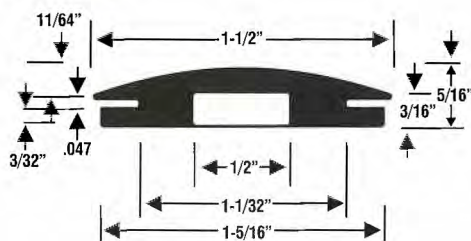

M-307

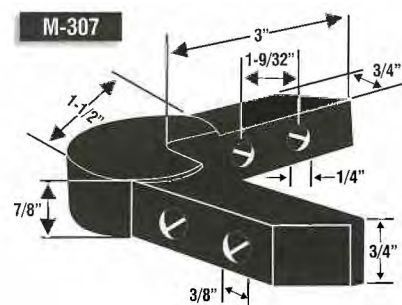





3M BUMPERS

The following genuine 3M bumpers are designated by width and height and are available in colors as listed. These bumpers are made of resilient polyurethane polymer. Their uniqueness is their high coefficient of friction, non-slip, non-marking and long life properties.





TRANSPARENT

Product Number
Colors
Width (Inches/mm)
Height (Inches/mm)

| | | | |
|---|---|--|---|
|  |  |  |  |
| B-8302-C | B-8306-C | B-8303-C | B-8312-C |
| Transparent | Transparent | Transparent | Transparent |
| 0.312/7.9 | 0.375/9.5 | 0.44/11.1 | 0.50/12.7 |
| 0.085/2.2 | 0.150/3.8 | 0.20/5.0 | 0.14/3.5 |

HEMISPHERE

Product Number
Colors
Width (Inches/mm)
Height (Inches/mm)

| | | | |
|---|---|--|---|
|  |  |  |  |
| B-8003 | B-8027 | B-8017 | B-8009 |
| White, Gray, Brown, Black | White, Gray, Brown, Black | White, Gray, Brown, Black | White, Gray, Brown, Black |
| 0.44/11.1 | 0.63/16.0 | 0.75/19.0 | 0.88/22.3 |
| 0.20/5.0 | 0.31/7.9 | 0.38/9.6 | 0.40/10.1 |

CYLINDRICAL

Product Number
Colors
Width (Inches/mm)
Height (Inches/mm)

| | | | |
|---|---|--|---|
|  |  |  |  |
| B-8112 | B-8001 | B-8744 | B-8014 |
| White, Gray, Brown, Black | Black, Gray | Black | White, Gray, Brown, Black |
| 0.50/12.7 | 0.50/7.9 | 0.75/19 | 0.81/20.6 |
| 0.14/3.5 | 0.14/3.5 | 0.16/4.0 | 0.52/13.1 |



TAPERED SQUARE

Product Number
Colors
Width (Inches/mm)
Height (Inches/mm)

| | | | |
|---|---|--|---|
|  |  |  |  |
| B-8007 | B-8008 | B-8018 | B-8023 |
| Black | White, Gray, Brown, Black | White, Gray, Brown, Black | White, Gray, Brown, Black |
| 0.04/10.2 | 0.50/12.7 | 0.50/12.7 | 0.81/20.5 |
| 0.10/2.5 | 0.12/3.1 | 0.23/5.8 | 0.30/7.6 |

OTHER

Product Number
Colors
Width (Inches/mm)
Height (Inches/mm)

| | |
|---|---|
|  |  |
| B-8705 | B-8532 |
| Black | White, Gray, Brown, Black |
| 0.125/31.75 | 1.88/47.7 |
| 0.24/6.1 | 0.66/16.7 |

**Call For
Quantity Discounts**

LABORATORY STOPPERS

Below are standard lab stopper sizes, available with one hole, two holes and in solid. **Material:** 50 durometer black rubber. Neoprene and Pure Gum are available through special order.

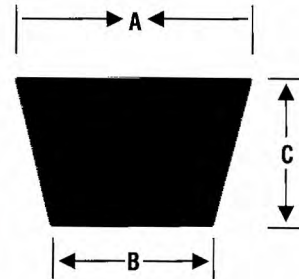

| SIZE # | A (MM) TOP | B (MM) BOTTOM | C (MM) LENGTH | A (INCHES) TOP | B (INCHES) BOTTOM | C (INCHES) LENGTH | PART# |
|--------|------------------|---------------------|---------------------|----------------------|-------------------------|-------------------------|--------|
| MS-1 | 12.7 | 3 | 50 | .500" | .120" | 1.97" | L-MS-1 |
| 000 | 12 | 9 | 18 | .472" | .354" | .709" | L-000 |
| 00 | 15 | 10 | 25 | .591" | .400" | .955" | L-00 |
| 0 | 17 | 13 | 25 | .669" | .512" | .984" | L-0 |
| 1 | 19 | 14 | 25 | .748" | .551" | .984" | L-1 |
| 2 | 20 | 16 | 25 | .787" | .630" | .984" | L-2 |
| 3 | 24 | 18 | 25 | .945" | .709" | .984" | L-3 |
| 4 | 26 | 20 | 25 | 1.024" | .787" | .984" | L-4 |
| 5 | 27 | 23 | 25 | 1.063" | .906" | .984" | L-5 |
| 5-1/2 | 28 | 24 | 25 | 1.102" | .945" | .984" | L-5.5 |
| 6 | 32 | 26 | 25 | 1.260" | 1.024" | .984" | L-6 |
| 6-1/2 | 34 | 27 | 25 | 1.339" | 1.063" | .984" | L-6.5 |
| 7 | 37 | 30 | 25 | 1.457" | 1.181" | .984" | L-7 |
| 7-1/2 | 39 | 31 | 25 | 1.535" | 1.220" | .984" | L-7.5 |
| 8 | 41 | 33 | 25 | 1.614" | 1.299" | .984" | L-8 |
| 8-1/2 | 43 | 36 | 25 | 1.693" | 1.417" | .984" | L-8.5 |
| 9 | 45 | 37 | 25 | 1.772" | 1.457" | .984" | L-9 |
| 9-1/2 | 46 | 38 | 25 | 1.811" | 1.496" | .984" | L-9.5 |
| 10 | 50 | 42 | 25 | 1.969" | 1.654" | .984" | L-10 |
| 10-1/2 | 53 | 45 | 25 | 2.087" | 1.772" | .984" | L-10.5 |
| 11 | 56 | 48 | 25 | 2.205" | 1.890" | .984" | L-11 |
| 11-1/2 | 63 | 50 | 25 | 2.480" | 1.969" | .984" | L-11.5 |
| 12 | 64 | 54 | 25 | 2.520" | 2.126" | .984" | L-12 |
| 13 | 68 | 58 | 25 | 2.677" | 2.283" | .984" | L-13 |
| 13-1/2 | 75 | 62 | 35 | 2.953" | 2.441" | 1.378" | L-13.5 |
| 14 | 90 | 75 | 39 | 3.543" | 2.953" | 1.535" | L-14 |
| 15 | 103 | 83 | 39 | 4.055" | 3.268" | 1.535" | L-15 |

Laboratory Stoppers

- ▼ Use to pressure check pipes and fittings.
- ▼ Use to plug holes.
- ▼ Use to seal off pipe ends and keep contaminants out.
- ▼ Green Neoprene and pure gum stoppers are also available. Call for minimum order quantities and delivery.
- ▼ For 1 & 2 Hole Stoppers Add -1 or -2 After The Part Number.
Example: L-000-1 or L-000-2.

**If You Have Questions
About Rubber,
We're Here To Help**

CRUTCH TIPS

Below are various sizes of Standard Crutch Tips. All sizes are available in black, white or grey, with custom colors available through special order. Tips may be ordered in the "heavy duty" style (ribbed outside wall) or the "contemporary" style (smooth outside wall).

Material: 60 durometer black SBR.

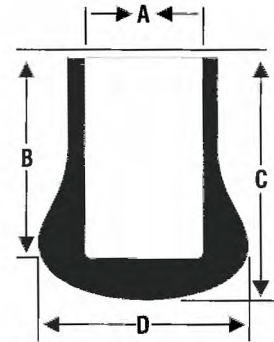

| A INSIDE DIAMETER | B INSIDE DEPTH | C TOTAL HEIGHT | D BOTTOM WIDTH | SIZE # | PART # |
|-------------------------|----------------------|----------------------|----------------------|--------|--------|
| 1/4" | 5/8" | 25/32" | 11/16" | 14 | M-0014 |
| 3/8" | 7/8" | 1-1/8" | 13/16" | 15 | M-0510 |
| 1/2" | 1" | 1-1/4" | 15/16" | 16 | M-0492 |
| 5/8" | 1-1/8" | 1-3/8" | 1-3/32" | 17 | M-0500 |
| 3/4" | 1-1/4" | 1-3/4" | 1-1/4" | 18 | M-0067 |
| 7/8" | 1-1/2" | 1-7/8" | 1-3/8" | 19 | M-0066 |
| 1" | 1-1/2" | 1-7/8" | 1-5/8" | 20 | M-0064 |
| 1-1/8" | 1-3/8" | 1-7/8" | 1-11/16" | 21 | M-0065 |
| 1-1/4" | 1-3/8" | 1-7/8" | 1-7/8" | 22 | M-0581 |

**Call About Our
Quantity Discounts**

**Samples Available
For Your Evaluation**

*Design Your Own Part and We'll
Stock It for Your Ongoing Requirements*



END TIPS

Stock end tips are available in 60 durometer black SBR. Listed below by increasing **Inside Diameter (A)** are the end tips that are considered stock items. Check our manufactured end tip section if you cannot find a particular item in this section. **Low minimum orders for stocked parts.**



| SEE DRAWING | A INSIDE DIAMETER | B TOTAL HEIGHT | C RECESS DEPTH | D TOP DIAMETER | E BOTTOM DIAMETER | PART # |
|-------------|-------------------------|----------------------|----------------------|----------------------|-------------------------|---------|
| 6 | 3/32" | 5/8" | 17/32" | 3/16" | 3/16" | M-0858 |
| 5 | 1/8" | 19/64" | 7/32" | 1/4" | 1/4" | M-46183 |
| 4 | 9/64" | 1/4" | 5/32" | 11/32" | 11/32" | M-1391 |
| 5 | 5/32" | 17/32" | 7/16" | 23/64" | 23/64" | M-1235 |
| 4 | 5/32" | 3/8" | 1/4" | 5/16" | 5/16" | M-0013 |
| 3 | 3/16" | 1/2" | 3/8" | 1/4" | 3/8" | M-40620 |
| 1 | 7/32" | 29/32" | 11/16" | 3/8" | 15/32" | M-1873 |
| 4 | 1/4" | 19/32" | 11/32" | 17/32" | 17/32" | M-1684 |
| 1 | 19/64" | 29/32" | 11/16" | 3/8" | 15/32" | M-1872 |
| 5 | 5/16" | 9/16" | 7/16" | 23/64" | 23/64" | M-42943 |
| 1 | 3/8" | 5/8" | 1/2" | 1/2" | 1/2" | M-46253 |
| 1 | 13/32" | 29/32" | 11/16" | 15/32" | 9/16" | M-1875 |
| 3 | 3/4" | 1" | 3/4" | 15/16" | 1-1/16" | M-0152 |



Stock End Tips

Protects screw threads.

Provides protection from sharp screw projections.

Rod end protectors.

Use as bumper to protect surfaces from equipment.

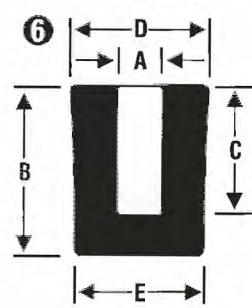
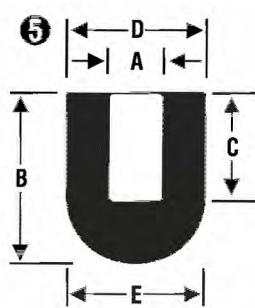
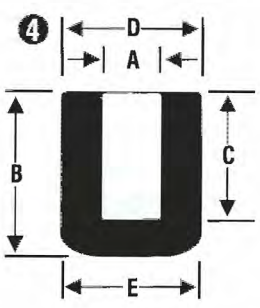
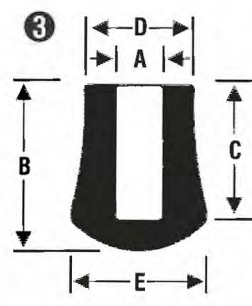
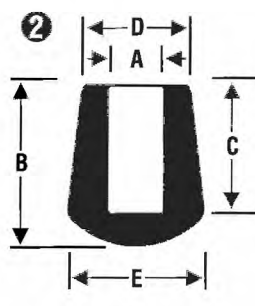
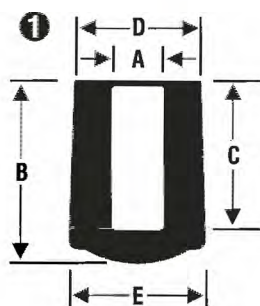

Let Us Know Your Requirements And We'll Stock The Items For *Fast Shipping*

BUNA-N

? A term referring to Nitrile (*Butadiene Acrylonitrile*). Nitrile is used primarily for applications requiring **excellent resistance to petroleum oils and gasoline**. Nitrile also has **excellent resistance to mineral & vegetable oils**. Nitrile should not be used with solvents such as acetone, methylethyl ketone or other ketones.

MANUFACTURED END TIPS

Listed below by increasing **Inside Diameter (A)** are manufactured end tips available in a variety of materials. Minimums for production runs apply; please call for specific information. Normal delivery is 4-6 weeks with a minimum order of \$200.00, but a special 10-working-day expedite is offered on most manufactured parts.

| SEE DRAWING | A INSIDE DIAMETER | B TOTAL HEIGHT | C RECESS DEPTH | D TOP DIAMETER | E BOTTOM DIAMETER | PART # |
|-------------|-------------------------|----------------------|----------------------|----------------------|-------------------------|---------|
| 5 | 1/16" | 3/4" | 5/8" | 3/8" | 3/8" | M-40618 |
| 4 | 3/32" | 1/4" | 3/16" | 1/4" | 1/4" | M-40627 |
| 5 | 3/32" | 7/8" | 1/2" | 1/2" | 1/2" | M-46182 |
| 5 | 1/8" | 7/16" | 5/16" | 7/32" | 1/4" | M-40125 |
| 1 | 1/8" | 7/8" | 3/4" | 3/8" | 7/16" | M-42051 |
| 3 | 1/8" | 1/2" | 3/8" | 1/4" | 3/8" | M-46201 |
| 1 | 5/32" | 7/8" | 3/4" | 3/8" | 7/16" | M-42053 |
| 6 | 5/32" | 1/2" | 3/8" | 7/32" | 7/32" | M-46208 |
| 6 | 3/16" | 1-1/4" | 1" | 3/8" | 3/8" | M-40623 |
| 4 | 3/16" | 11/16" | 5/8" | 3/8" | 3/8" | M-40631 |
| 1 | 7/32" | 7/8" | 3/4" | 3/8" | 7/16" | M-40205 |
| 4 | 7/32" | 3/8" | 1/4" | 1/2" | 1/2" | M-40628 |
| 6 | 7/32" | 3/8" | 5/16" | 1/2" | 1/2" | M-42731 |
| 3 | 15/64" | 15/32" | 3/8" | 5/16" | 13/32" | M-40626 |
| 2 | 15/64" | 11/16" | 1/2" | 29/64" | 17/32" | M-46292 |
| 2 | 1/4" | 13/16" | 19/32" | 1/2" | 5/8" | M-40635 |
| 5 | 1/4" | 3/8" | 9/32" | 3/8" | 3/8" | M-46207 |
| 6 | 1/4" | 17/64" | 7/32" | 11/32" | 11/32" | M-42958 |

Manufactured End Tips

Various materials and durometers available.

Fast turnaround on manufactured parts.

Use the correct material for your job, and don't over or under buy.

Our job is to have it in stock when you need it.

If you have a question about rubber you need answered, call us...we're here to help.

Call About Our Quantity Discounts

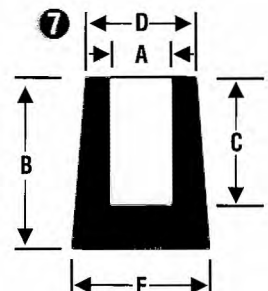
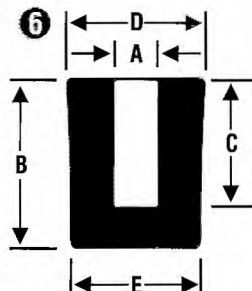
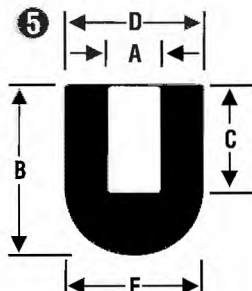
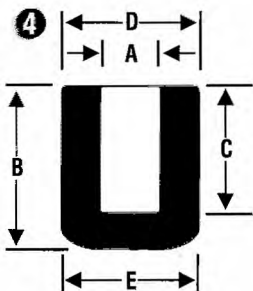
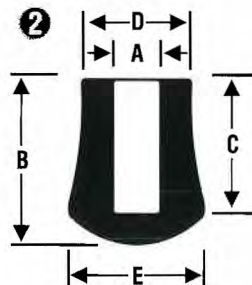
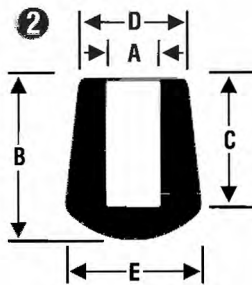
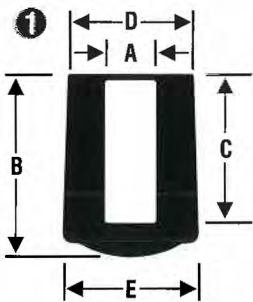

MANUFACTURED END TIPS, CONTINUED

| SEE DRAWING | A INSIDE DIAMETER | B TOTAL HEIGHT | C RECESS DEPTH | D TOP DIAMETER | E BOTTOM DIAMETER | PART # |
|-------------|-------------------------|----------------------|----------------------|----------------------|-------------------------|---------|
| 2 | 17/64" | 11/16" | 1/2" | 29/64" | 17/32" | M-46293 |
| 1 | 19/64" | 3/4" | 17/32" | 27/64" | 15/32" | M-42052 |
| 2 | 19/64" | 11/16" | 1/2" | 29/64" | 17/32" | M-46291 |
| 4 | 5/16" | 3/8" | 1/4" | 7/16" | 7/16" | M-40633 |
| 2 | 21/64" | 11/16" | 1/2" | 29/64" | 17/32" | M-40629 |
| 7 | 21/64" | 5/8" | 1/2" | 15/32" | 5/8" | M-46251 |
| 7 | 21/64" | 7/16" | 5/16" | 1/2" | 5/8" | M-46224 |
| 7 | 11/32" | 1-1/8" | 1" | 1/2" | 9/16" | M-40636 |
| 7 | 3/8" | 5/8" | 1/2" | 15/32" | 5/8" | M-46252 |
| 1 | 3/8" | 5/8" | 1/2" | 1/2" | 1/2" | M-46253 |
| 2 | 13/32" | 29/32" | 11/16" | 1/2" | 19/32" | M-40630 |
| 2 | 15/32" | 3/4" | 1/2" | 19/32" | 11/16" | M-46222 |
| 2 | 1/2" | 3/4" | 1/2" | 5/8" | .725 | M-40622 |
| 2 | 9/16" | 11/16" | 1/2" | 11/16" | 13/16" | M-46223 |
| 2 | 5/8" | 1" | 3/4" | 3/4" | 7/8" | M-40673 |
| 2 | 13/16" | 1-1/8" | 7/8" | 1" | 1-1/8" | M-40682 |
| 2 | 13/16" | 7/8" | 5/8" | 1" | 1/1/8" | M-46821 |
| 4 | 1" | 1-1/4" | 1-1/8" | 1-1/4" | 1-1/4" | M-40681 |

Samples Available
For Your Evaluation

Blanket Orders
Accepted With Firm
Release Dates,
Allowing For
Larger Quantity
Discounts

SILICONE

? A material that can be made to withstand temperatures as high as 600°F and still retain its flexibility to -150°F. **Silicone is resistant to chemical deterioration, oils, oxygen & ozone.** Chemical inertness makes this material great for surgical & food processing equipment.

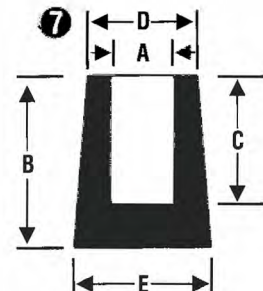
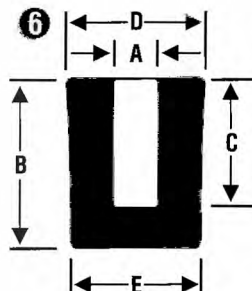
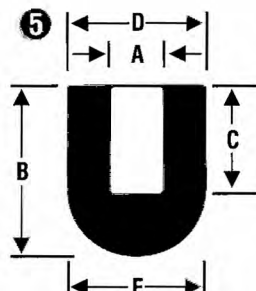
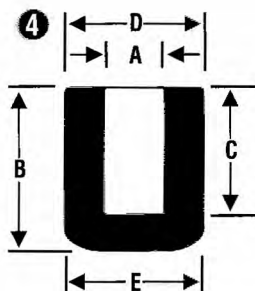
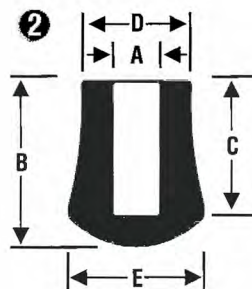
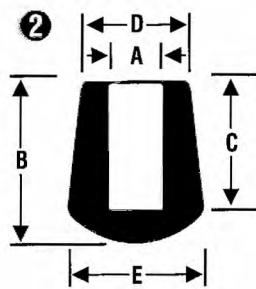
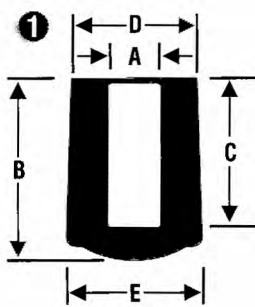

STEP BUSHINGS

Step bushings are available in 60 durometer black SBR. Listed below by increasing **Inside Diameter (A)** are the step bushings that are considered stock items. Check our manufactured step bushings section if you cannot find a particular item in this section.

Low minimum orders for stocked parts.



**Samples Available
For Your Evaluation**

| A INSIDE DIAMETER | B STEP DIAMETER | C OUTSIDE DIAMETER | D HEAD HEIGHT | E TOTAL HEIGHT | PART # |
|-------------------------|-----------------------|--------------------------|---------------------|----------------------|---------|
| 1/8" | 1/4" | 3/8" | 7/64" | 3/8" | M-0962 |
| 9/64" | 1/2" | 3/4" | 1/8" | 3/8" | M-1015 |
| 5/32" | 1/4" | 3/8" | 1/8" | 3/16" | M-67102 |
| 11/64" | 9/32" | 1/2" | 3/32" | 13/64" | M-0795 |
| 3/16" | 5/8" | 1" | 1/4" | 3/4" | M-0017 |
| 3/16" | 7/16" | 17/32" | 1/8" | 1/2" | M-67042 |
| 7/32" | 7/16" | 1" | 1/8" | 5/16" | M-0232 |
| 1/4" | 13/32" | 5/8" | 3/32" | 13/32" | M-1681 |
| 1/4" | 7/16" | 5/8" | 13/64" | 1/4" | M-0748 |
| 1/4" | 3/8" | 3/4" | 1/8" | 1/2" | M-0174 |
| 1/4" | 1/2" | 1" | 1/4" | 3/8" | M-67091 |
| 5/16" | 5/8" | 1" | 1/4" | 19/32" | M-0029 |
| 3/8" | 21/32" | 7/8" | 3/16" | 3/8" | M-0256 |
| 3/8" | 15/16" | 1-3/16" | 5/64" | 27/64" | M-0871 |
| 7/16" | 13/16" | 1-1/4" | 1/2" | 37/64" | M-60711 |

Stock Step Bushings

▼ If you can't find the part you are looking for in this catalog, please call. We have the capability to make any part you need.

▼ When you need help in determining sizes or specifications for your item, our professional staff is always available to help.

▼ Our goal is to have your bushing in stock when you need it, whether it's a standard stock part or one of your custom part requirements.

▼ We offer one of the largest inventories of stock step bushings in the industry.

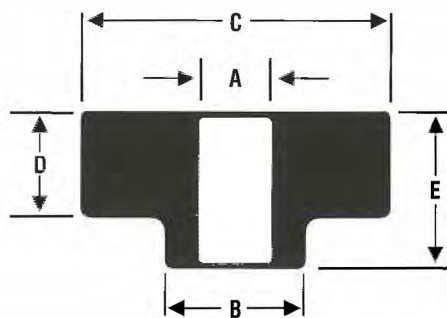

ELONGATION

? Describes the innate ability of a rubber compound to stretch without breaking. It is expressed a percent of original length.

MANUFACTURED STEP BUSHINGS

Listed below by increasing **Inside Diameter (A)** are manufactured step bushings available in a variety of materials and durometers. Minimums for production runs apply; please call for specific information. Normal delivery is 4-6 weeks with a minimum order of \$200.00, but a special 10-working-day expedite is offered on most manufactured parts.

| A INSIDE DIAMETER | B STEP DIAMETER | C OUTSIDE DIAMETER | D HEAD HEIGHT | E TOTAL HEIGHT | PART # |
|-------------------------|-----------------------|--------------------------|---------------------|----------------------|---------|
| 1/32" | 3/32" | 1/2" | 1/8" | 1/4" | M-67041 |
| 1/8" | 3/16" | 3/8" | 1/16" | 3/32" | M-60702 |
| 1/8" | 1/4" | 3/8" | 1/8" | 3/8" | M-67024 |
| 11/64" | 19/64" | 27/64" | 5/64" | 1/4" | M-60703 |
| 3/16" | 3/8" | 9/16" | 1/8" | 1/4" | M-60705 |
| 3/16" | 5/16" | 5/8" | 1/16" | 7/64" | M-67061 |
| 3/16" | 13/64" | 5/8" | 1/8" | 7/32" | M-67062 |
| 7/32" | 5/16" | 13/32" | 5/64" | 3/16" | M-67021 |
| 7/32" | 19/64" | 3/8" | 5/64" | 3/16" | M-67023 |
| 7/32" | 3/8" | 3/4" | 1/8" | 5/16" | M-67073 |
| 7/32" | 5/8" | 1" | 3/8" | 17/32" | M-67092 |
| 1/4" | 7/16" | 5/8" | 3/16" | 1/4" | M-60706 |
| 1/4" | 1/2" | 1" | 11/32" | 17/32" | M-60709 |
| 1/4" | 1/2" | 3/4" | 3/16" | 3/8" | M-67071 |
| 5/16" | 15/32" | 3/4" | 5/16" | 5/8" | M-60707 |
| 5/16" | 1/2" | 7/8" | 1/4" | 3/8" | M-60708 |
| 5/16" | 1/2" | 3/4" | 3/16" | 3/8" | M-67072 |
| 5/16" | 5/8" | 1" | 3/16" | 3/8" | M-67096 |
| 21/64" | 1/2" | 1-1/4" | 3/8" | 9/16" | M-60710 |
| 21/64" | 5/8" | 63/64" | 3/16" | 21/64" | M-67074 |
| 11/32" | 3/4" | 1" | 3/8" | 1-1/8" | M-62521 |
| 3/8" | 11/16" | 1-1/4" | 3/8" | 1/2" | M-62901 |
| 3/8" | 5/8" | 15/16" | 1/4" | 3/8" | M-67081 |
| 3/8" | 1/2" | 1-1/4" | 3/8" | 9/16" | M-67101 |
| 7/16" | 3/4" | 1-3/8" | 3/16" | 7/16" | M-67063 |

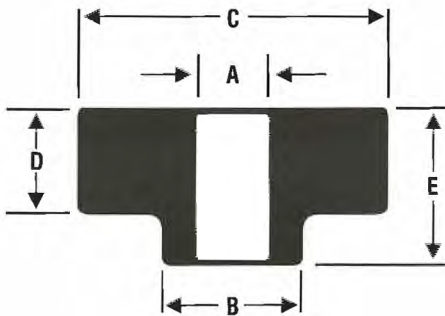

Manufactured Step Bushings

▼ If you can't find the part you are looking for in this catalog, please call. We have the capability to make any part you need.

▼ When you need help in determining sizes or specifications for your bushing requirements, our staff is knowledgeable and ready to help.

▼ Our goal is to have your bushing in stock when you need it. Let us know your requirements and we will stock the item for shipping according to your schedule.

**Blanket Orders
Accepted With Firm
Release Dates,
Allowing For
Larger Quantity
Discounts**

**Samples Available
For Your Evaluation**

TENSILE STRENGTH

? Refers to a rubber compound's resistance to rupture under tension. It is measured as strength at break and expressed in pounds per square inch of cross section.

EXTRUSIONS

We stock a full selection of U-Channels, with the capability to handle large extrusion orders. We also offer runs as small as 100-feet on custom profiles; **send us your sketch or print.** **Material:** 70 durometer black EPDM.

| A SLOT WIDTH | B LEG WIDTH | C OVERALL WIDTH | D SLOT DEPTH | E BASE DEPTH | F OVERALL DEPTH | PART # |
|--------------------|-------------------|-----------------------|--------------------|--------------------|-----------------------|--------|
| 1/32" | 1/32" | 3/32" | 3/16" | 1/32" | 7/32" | E-0892 |
| 1/32" | 1/16" | 5/32" | 5/32" | 1/32" | 3/16" | E-0142 |
| 3/64" | 1/32" | 7/64" | 1/8" | 1/32" | 5/32" | E-0661 |
| 1/16" | 1/16" | 3/16" | 5/16" | 1/16" | 3/8" | E-0172 |
| 1/16" | 1/16" | 3/16" | 1/8" | 1/8" | 1/4" | E-0195 |
| 1/16" | 1/32" | 1/8" | 5/32" | 1/32" | 3/16" | E-0538 |
| 1/16" | 1/32" | 1/8" | 13/64" | 1/16" | 17/64" | E-0945 |
| 3/32" | 5/64" | 1/4" | 7/16" | 3/16" | 5/8" | E-0129 |
| 3/32" | 3/64" | 3/16" | 17/64" | 3/64" | 5/16" | E-0379 |
| 3/32" | 1/16" | 7/32" | 1/8" | 1/16" | 3/16" | E-0566 |
| 3/32" | 1/16" | 7/32" | 1/4" | 1/16" | 5/16" | E-0541 |
| 1/8" | 1/16" | 1/4" | 1/4" | 1/16" | 5/16" | E-0102 |
| 1/8" | 3/64" | 7/32" | 13/64" | 3/64" | 1/4" | E-0299 |
| 1/8" | 3/32" | 5/16" | 9/32" | 3/32" | 3/8" | E-0526 |
| 1/8" | 3/32" | 5/16" | 3/8" | 1/8" | 1/2" | E-0688 |
| 1/8" | 3/64" | 7/32" | 11/64" | 3/64" | 7/32" | E-0693 |
| 1/8" | 1/32" | 3/16" | 7/16" | 1/16" | 1/2" | E-0830 |
| 1/8" | 1/16" | 1/4" | 9/16" | 1/16" | 5/8" | E-0874 |
| 3/16" | 1/8" | 7/16" | 3/8" | 1/8" | 1/2" | E-0211 |
| 3/16" | 1/16" | 5/16" | 1/4" | 1/16" | 5/16" | E-1146 |
| 3/16" | 1/16" | 5/16" | 3/8" | 1/16" | 7/16" | E-0341 |
| 1/4" | 1/16" | 3/8" | 7/32" | 1/16" | 9/32" | E-0770 |
| 1/4" | 1/16" | 3/8" | 5/16" | 1/16" | 9/32" | E-0836 |
| 1/4" | 1/8" | 1/2" | 1/2" | 1/8" | 5/8" | E-0982 |
| 5/16" | 1/16" | 7/16" | 7/16" | 1/16" | 1/2" | E-2282 |
| 5/16" | 1/8" | 9/16" | 5/16" | 1/8" | 7/16" | E-2345 |
| 3/8" | 1/8" | 5/8" | 11/16" | 1/8" | 13/16" | E-0234 |
| 3/8" | 1/16" | 1/2" | 3/8" | 1/16" | 7/16" | E-0950 |
| 1/2" | 1/8" | 3/4" | 5/8" | 1/8" | 3/4" | E-1386 |
| 5/8" | 1/8" | 7/8" | 3/4" | 1/8" | 7/8" | E-1475 |
| 3/4" | 1/8" | 1" | 5/8" | 1/8" | 3/4" | E-1385 |
| 7/8" | 1/8" | 1-1/8" | 1/2" | 1/8" | 5/8" | E-3439 |
| 1" | 1/8" | 1-1/4" | 1/2" | 1/8" | 5/8" | E-0981 |

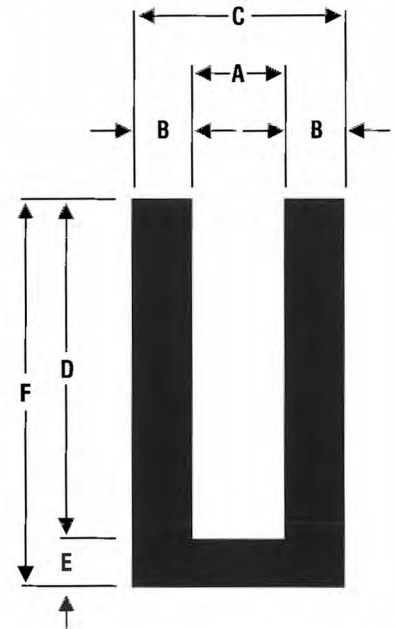

U-Channel Extrusions

Use as a protective edge on sheet metal or rough-cut parts.

Use as cosmetic trim.

U-Channels make economical seals.

EPDM

(Ethylene Propylene)
 EPDM rubber is rated as excellent in weather aging, oxidation, heat aging and water swell resistance. Temperature range -60° F through 300° F.

Custom Short-Run Extrusions

▼ We have the capability to handle very large extrusion runs, as well as the increasingly popular smaller prototype runs.

▼ With our extrusion program, you are not bound by any profile. Send us your part, a drawing or fill in the dimensions on one of our profiles and we can run as little as 100 feet.

▼ Extrusions can be run coiled or in straight lengths.

▼ Call us for all your rubber extrusion requirements and let one of our knowledgeable staff members help you order the correct extrusion and quantity that you need to complete your job.

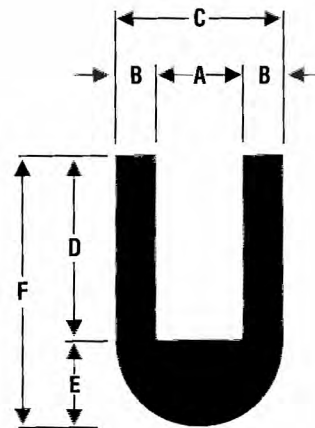
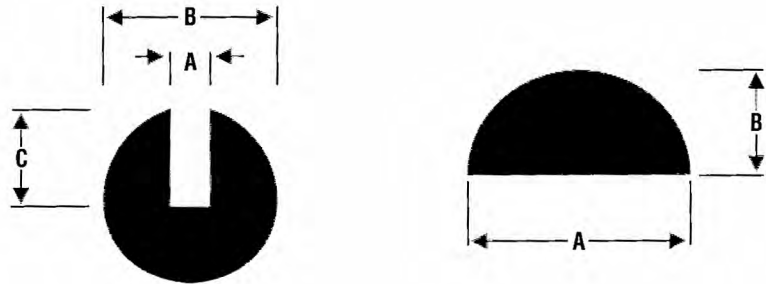

Short-Run Extrusion Benefits

▼ Easy-to-handle requirements for short-run projects.

▼ 100-Foot minimum runs.

▼ Top-quality materials available including:

- 70-EPDM (black or white)
- 70-Neoprene
- 70-Buna-N

▼ Fast 3-4 week delivery.

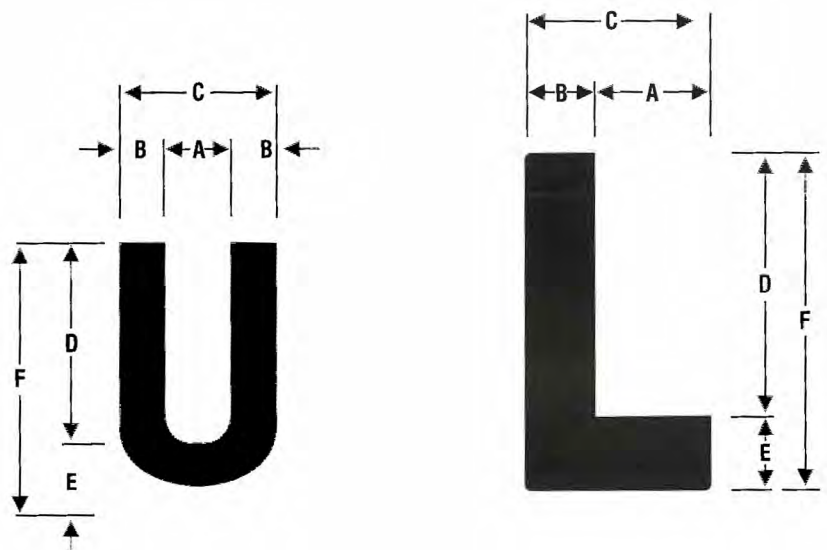

**We Can Meet Your
Large Or Small Run
Extrusion Requirements**

Call For A Quote
On Your Next Project

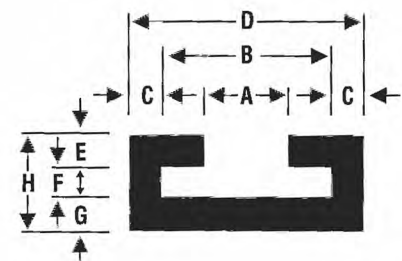
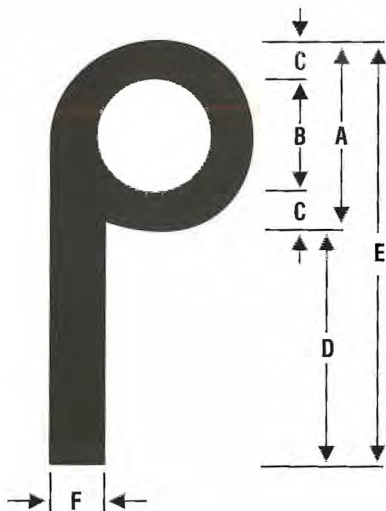
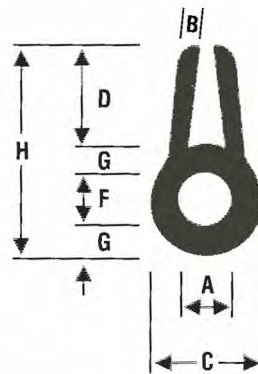
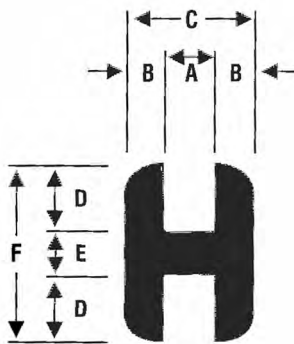
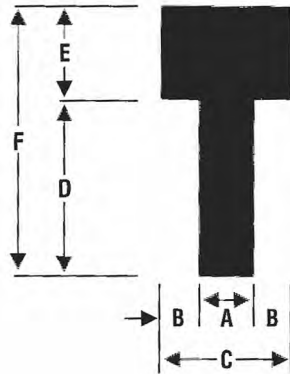

Custom Extrusions

We have the capability to handle very large extrusion runs, as well as the increasingly popular smaller prototype runs.

With our extrusion program, you are not bound by any profile. Send us your part, a drawing or fill in the dimensions on one of our profiles and we'll take it from there.

Extrusions can be run coiled or in straight lengths.

Colors are available through special order.

Custom Extrusion Materials

We can supply custom extrusions to your dimensions and exact specifications in a wide variety of quality materials...

- EPDM
- Neoprene
- Buna-N
- Silicone
- Vinyl
- Flexible PCV
- Sponge

LIFTER TOOLS

Lift, move or grab any non-porous materials, **keeping employees' hands at a safe distance from dangerous working areas.** Replacement parts for the vacuum tools are also available, including rubber cups and internal vacuum valve assemblies.

LIGHT DUTY

MHT-1230 2-1/8" Cup

MHT-5157 2-5/8" Cup



Quick Release
with the touch of a finger

Medium-Heavy 4-Finger Tool

MHT-4875 4-3/4" Cup



Quick Release
with the touch of a finger

Medium-Duty 2-Finger Tool

MHT-3825 3-1/4" Cup



Quick Release
with the touch of a finger

Heavy-Duty Hand Grip Tool

MHT-G609 3-1/4" Cup



Lift Anywhere
on top edge to release

Promotes Safety

Designed To Add *Safety & Speed* To Punch Press Work

Medium-Duty Hand Grip Tool

MHT-2260 3-1/4" Cup

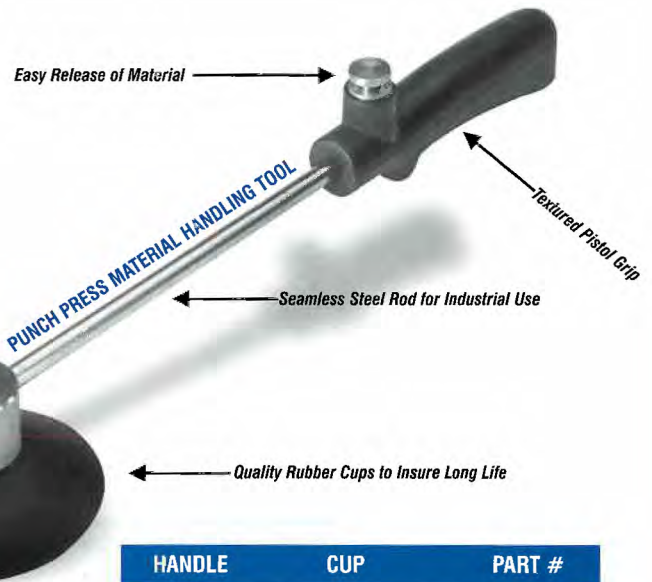

Heavy-Duty Handling (Sheet Metal Tool)

MHT-1859 4" Cup

MHT-1919 5" Cup



| HANDLE | CUP | PART # |
|--------|---------------|----------|
| 12" | Single 2-1/8" | MHT-6464 |
| 12" | Single 3-1/4" | MHT-6467 |
| 12" | Single 4" | MHT-6470 |
| 15" | Single 2-1/8" | MHT-6465 |
| 15" | Single 3-1/4" | MHT-6468 |
| 15" | Single 4" | MHT-6471 |
| 18" | Single 2-1/8" | MHT-6466 |
| 18" | Single 3-1/4" | MHT-6469 |
| 18" | Single 4" | MHT-6472 |
| 12" | Double 2-1/8" | MHT-6461 |
| 15" | Double 2-1/8" | MHT-6462 |
| 18" | Double 2-1/8" | MHT-6463 |

Heavy-Duty Double Cup (Sheet Metal Tool)

MHT-6540 2 Cups 4" ea.

MHT-6541 2 Cups 5" ea.



MEETS OSHA SAFETY REGULATIONS

OSHA regulations require that all punch press operators use a hand tool when feeding or removing work from the die.

SUCTION CUPS

Stock suction cups are constructed from high quality rubber. Listed below by increasing **Cup Diameter (A)** are the suction cups that are considered stock items. Check our manufactured suction cup section if you cannot find a particular item in this section. **Low minimum orders for stocked parts.**



| SEE DRAWING | A CUP DIAMETER | B CUP HEIGHT | C INSERT HEIGHT | INSERT TYPE | PART # |
|-------------|----------------|--------------|-----------------|-------------|---------|
| 1 | 1" | 7/16" | 1/4" | #8-32 | M-688M |
| 3 | 1" | 5/16" | 3/8" | #8-32 | M-7101M |
| 1 | 1-5/16" | 1/2" | 3/8" | #8-32 | M-840M |
| 2 | 1-5/16" | 11/16" | 1/4" | #8-32 | M-840F |
| 3 | 1-3/8" | 1/2" | 3/8" | #8-32 | M-7139M |
| 1 | 1-1/2" | 1/2" | 3/8" | #8-32 | M-0124M |
| 1 | 1-3/4" | 5/8" | 3/8" | #8-32 | M-672M |

Stock Suction Cups

▼ Inserts are molded in for a more secure hold.

▼ Constructed with high quality rubber to insure long life

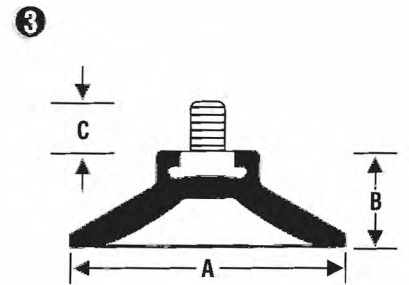
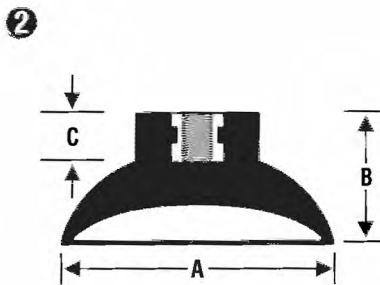
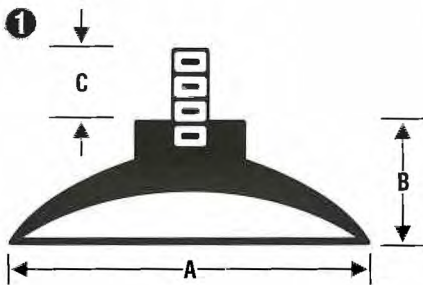

M-1293 Tan 30 Duro

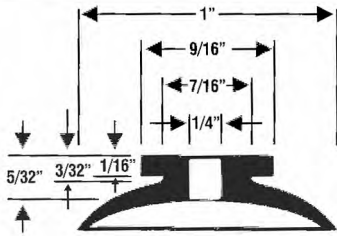

M-123 Tan 30 Duro

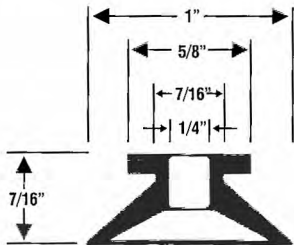

M-472 Tan 30 Duro

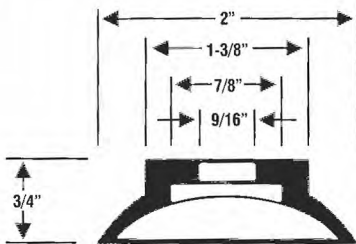

M-70312-F Grey Non-Staining 50 Duro

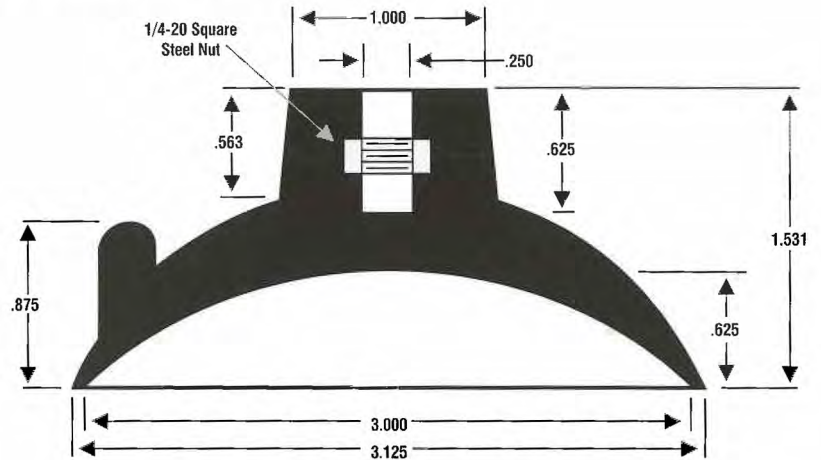

M-70312-F Grey Non-Staining 50 Duro

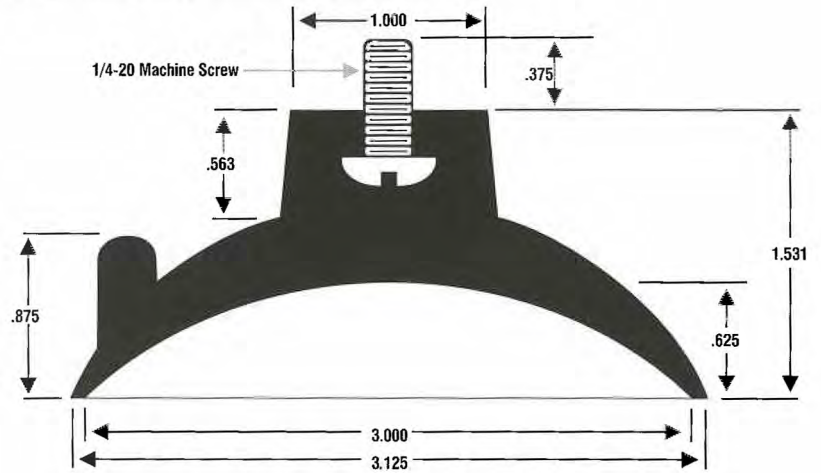

M-70400-M Black 50 Duro

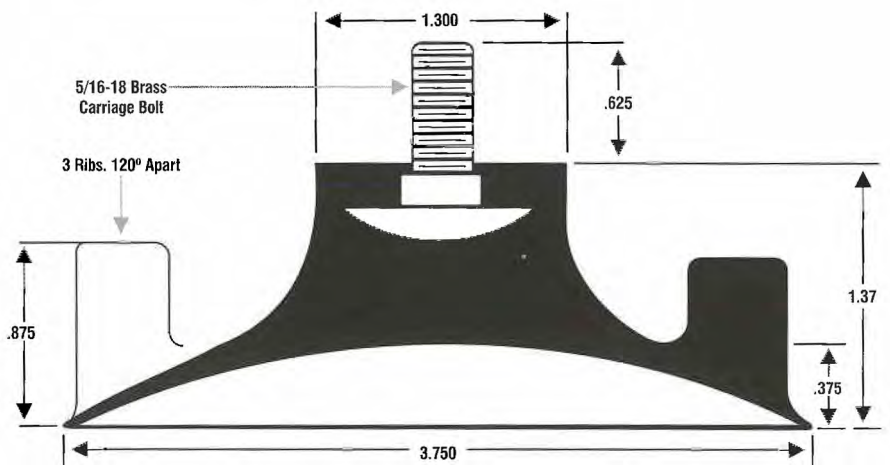

MANUFACTURED SUCTION CUPS

Listed below by increasing **Cup Diameter (A)** are manufactured suction cups constructed from high quality rubber. Minimums for production runs apply; please call for specific information. Normal delivery is 4-6 weeks with a minimum order of \$200.00, but a special 10-working-day expedite is offered on most manufactured parts.

| SEE DRAWING | A CUP DIAMETER | B TOTAL HEIGHT | C TOP HEIGHT | D INSERT TYPE | E TOP DIAMETER | F GROOVE WIDTH | PART# |
|-------------|----------------|----------------|--------------|---------------|----------------|----------------|-----------|
| 3 | 19/32" | 7/16" | 7/32" | | 5/16" | | M-70251 |
| 2 | 19/32" | 7/16" | 7/32" | 1/4" | 5/16" | 3/64" | M-70252 |
| 3 | 7/8" | 3/4" | 5/16" | 7/64" | 3/8" | | M-70875 |
| 3 | 7/8" | 3/4" | 5/16" | | 3/8" | | M-70877 |
| 2 | 1" | 7/16" | 9/32" | 3/8" | 1/2" | 1/32" | M-71001 |
| 2 | 1" | 7/16" | 9/32" | 3/8" | 1/2" | 3/32" | M-71002 |
| 1 | 1" | 7/16" | 3/16" | #8-32 | 1/2" | | M-71310 |
| 2 | 1" | 7/16" | 1/8" | 3/8" | 1/2" | 1/32" | M-71310-1 |
| 2 | 1" | 7/16" | 1/8" | 3/8" | 1/2" | 1/16" | M-71310-2 |
| 2 | 1" | 7/16" | 1/8" | 3/8" | 1/2" | 3/32" | M-71310-3 |
| 1 | 1-1/4" | 17/32" | 3/16" | #8-32 | 5/8" | | M-71325 |
| 1 | 1-3/8" | 1/2" | 5/32" | #8-32 | 5/8" | | M-71374 |

Manufactured Suction Cups

▼ Inserts are molded in for a secure hold

▼ Constructed from high-quality rubber to insure long life

**Call About Our
Quantity Discounts**

TEAR RESISTANCE

? Refers to the **resistance to growth of a nick or cut** when tension is applied.

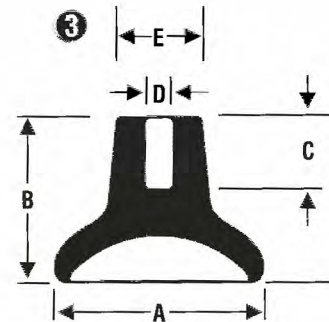
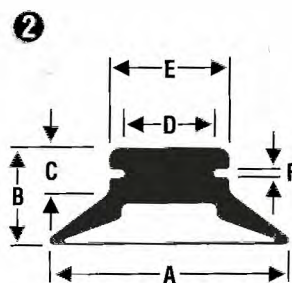
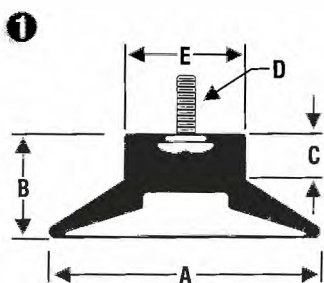

LORD VIBRATION MOUNTS

We are also authorized distributors for Lord Corporation. Lord is an industry leader in the manufacture of rubber-to-metal vibration isolation products. We stock a wide selection of their most popular mounts for same day shipping. Call us with your vibration or noise control problems.

Platform Mounts



Applications

Platform mounts are easy to install and provide space efficiency. Typical application includes electronic equipment, business machines, medical equipment and small pumps, engines and gen sets.

- Easy to install
- Uniform stress distribution
- Load ratings from .5 to 600 lbs.
- Square, diamond or holder configuration to suit a variety of design needs

Small Industrial Engine Mounts



Applications

The small engine mounts are especially designed for mounting 2, 3 & 4-cylinder gas or diesel engines in various types of vehicles & equipment.

- Moderately soft vertical stiffness
- Soft lateral and fore/aft stiffness
- Snubbed to limit travel in all directions
- Interlocked metals (when assembled with washers) provide safety restraint
- Well-suited for low mounting locations
- 120-300 lb. load ratings

Machinery Mounts



Applications

Lord Lattice, Chan-L and leveling mounts are designed to support heavy equipment and isolate intermittent or continuous vibration.

- High-efficiency, multi-directional isolation of low frequency vibration
- Extremely rugged and requires no maintenance
- Easy to install
- Long service life

Flex-Bolt Sandwich Mount

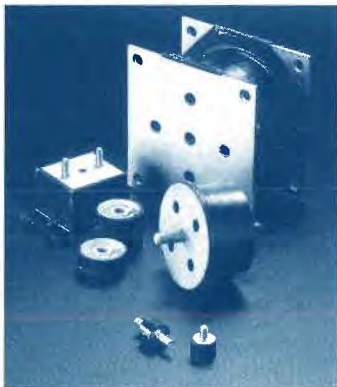

Applications

Sandwich mounts are designed to protect equipment and machinery against damaging vibration. These mounts provide high load carrying capacity and assure long life. Typical applications include business machines, motorcycles, HVAC equipment, light motors, appliances, compactors and feeders.

- Easy to install
- Male/male, Male/female types
- Load rating 1 Lb. to 13,400 Lbs.

Two-Piece Mounts



Applications

Two-piece mounts are designed for applications involving severe dynamic forces in the static load direction as well as the rebound direction. Typical applications include on and off highway vehicles, construction and industrial machines.

- Fail-safe assembly
- Long, dependable service life
- Prevents mechanical transmission of noise
- Accommodates misalignment

Center Bonded Mounts



Applications

Center bonded mounts isolate vibration, control shock and reduce noise due to structure-borne vibrations. They are ideal for automotive, marine, railroad and industrial markets.

- Vibration isolation in all directions
- Noise attenuation
- Easy, low-cost installation
- Space-saving size
- Captive installation after overload failure when recommended bolt, washer and nut are used

LATHE CUT PARTS



**If You Have Questions
About Rubber,
*We're Here To Help***

WE'RE YOUR SOURCE FOR LATHE CUT PARTS

WASHERS GASKETS SLEEVES
BUSHINGS RINGS BANDS

- Non-critical tolerance parts can be lathe cut from extruded rod stock
- Closer tolerance parts can be ground to the proper tolerances
- No mold or tooling cost
- Various materials and durometers available to meet your specifications

STOCK

SHEET RUBBER

We stock 60 durometer Neoprene sheet in the sizes listed below. Sheet rubber can be purchased from the roll or cut into stripping to your exact specifications.

| GAUGE | ROLL WIDTH | PART # |
|-------|------------|--------|
| 1/64" | 36" | SS-015 |
| 1/32" | 36" | SS-031 |
| 1/6" | 48" | SS-062 |
| 1/8" | 48" | SS-125 |
| 3/16" | 48" | SS-187 |
| 1/4" | 48" | SS-250 |
| 5/16" | 36" | SS-312 |
| 1/2" | 36" | SS-500 |

**A wide arrange of gasketing materials are also available.
Please call for more information.**

- NITRITE
- EPDM
- SILICONE
- GUM
- SPEC NEOPRENE
- CLOTH-INSERTED NEOPRENE
- VITON
- SILICONE SPONGE
- NEOPRENE SPONGE (closed/open cell)
- CORK

General Information

Standard Tolerances For Molded Parts

Standard Dimensional Tolerance Table

Molded Solid Rubber Products

Drawing Designation "A3" Commercial

| SIZE (INCHES) | FIXED | CLOSURE | SIZE (MILLIMETERS) | FIXED | CLOSURE |
|------------------------|---|------------|-----------------------|---|-----------|
| Above Incl. | | | Above Incl. | | |
| 0-.40 | $\pm .008$ | ± 0.13 | 0-10 | $\pm .20$ | $\pm .32$ |
| .40-.63 | .010 | .016 | 10-16 | .25 | .40 |
| .63-1.00 | .013 | .020 | 16-25 | .32 | .50 |
| 1.00-1.60 | .016 | .025 | 25-40 | .40 | .63 |
| 1.60-2.50 | .020 | .032 | 40-63 | .50 | .80 |
| 2.50-4.00 | .025 | .040 | 63-100 | .63 | 1.00 |
| 4.00-6.30 | .032 | .050 | 100-160 | .80 | 1.25 |
| 6.30 & Over | To find fixed dimensional tolerances multiply by 0.5% | | 160 & Over | To find fixed dimensional tolerances multiply by 0.5% | |

Drawing Designation "A3" tolerances indicate a "commercial" product and will normally be used for most products.

NOTE:

- (1) Fixed dimension tolerances apply individually to each fixed dimension by its own size.
- (2) Closure dimension tolerances are determined by the largest closure dimension and this single tolerance is used for all other closure dimensions.

Ordering Information

How To Order

The Astro-Tex Sales Department is open from 8:00 AM to 4:30 PM CST, Monday through Friday, except on national holidays. Parts that are in stock will be shipped the same day they are ordered, or, per your shipping schedule. There are several ways to order:

By Phone

Dial 972.424.8707 between 8:00 AM and 4:30 PM CST and speak to one of our experienced sales representatives.

By Fax

Dial 972.422.9791 and fax all relevant ordering information to our direct fax line.

By E-Mail

E-Mail your order to sales@astrotex.com

Credit Terms

Astro-Tex credit terms are net 30 days, FOB Plano, Texas from the invoice date. Credit can be arranged through an approved credit application. Payment can also be made by C.O.D., Visa or MasterCard. A late charge of 1-1/2% per month (18% Per Annum) will be assessed on past due balances.

Quantity Allowance

Astro-Tex reserves the right to consider shipments complete within a +/- 10% variable of the ordered quantity.

How To Return Goods

To return merchandise, please call 972.424.8707 and talk to one of our sales representatives. If the goods you ordered are returnable, we will provide you with an authorization name or number that must accompany the return shipment. All returns to Astro-Tex must be made prepaid, and a handling charge of 20% of the value of the merchandise will be deducted.

On defective material, Astro-Tex will pay for return freight. Credit will be issued and the corrected order will be re-invoiced at time of shipping.



Astro-Tex has been a source for quality molded and extruded rubber products since 1974. We have a large selection of standard rubber parts, along with a substantial variety of existing tools that can meet your requirements through manufacturing.

Astro-Tex has been meeting the rubber needs of many industries since our inception. Our products can be found in the appliance, furniture, construction, sporting good, truck & trailer and HVAC industries.

If you cannot find a part you need in this catalog, our new tooling prices are among the most competitive in the industry. Call us and we'll be happy to provide a bid on your special part to your specifications.